

Volume 23

PECATONICA RIVER

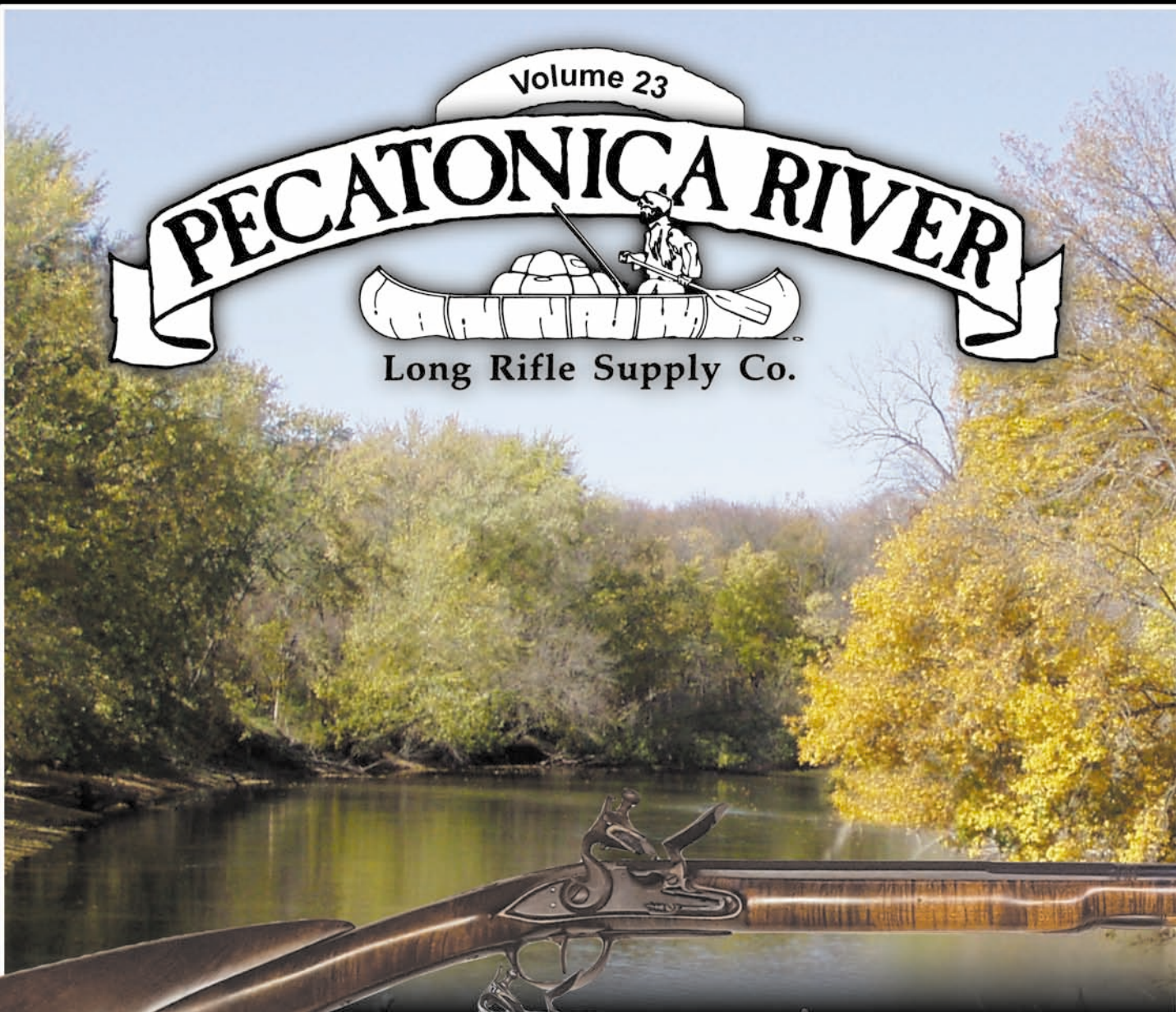

Long Rifle Supply Co.



Catalog of Goods for Rifle Builders, Gunsmiths,
Hunters & Black Powder Shooters

Index

Armstrong Rifle	4	Nipple Wrench	89
Art of Building a Rifle Book	1	North Carolina, Deep River	26
Ball Pullers	89	North Carolina	27
Ball Starters	91	Northwest Trade Gun	28
Barrels	46 - 49	Nose Caps	74
Barrel Keys	86	Ohio Rifle	29
Barrel Ribs	86	Order Form	94 - 96
Beck Boys Rifle	5	Ordering Information	2 & 3
Bedford County Rifle	6	Patchboxes	78 - 81
Blunderbuss	7	Pistol Stock Prices	3
Blunderbuss, 4 Bore	8	Powder Drums	90
Blunderbuss, 10 Bore	9	Powder Measures	91
Breech Plugs	50 & 51	Pre-Revolutionary Kentucky	13
Buttplates	62 - 65	Ramrods	87
Cappers	89	Ramrod Tips	87
Dickert, J Rifle	10	Rifle Stock Prices	3
Door Springs	81	Schuetzen Halfstock	30
Drum Drilling Jig	88	Schweitzer	31
Dueling Pistol	37	Screws	91
English Rigby Sporting Rifle	11	Sideplates	75 & 76
English Shot Gun	14	Sights	84 & 85
Flash Cups	92	Sling Swivels	90
Flints	90	Sling Button	92
Figthorn, A. Rifle	15	Southern Mountain Rifle	32
Finishing Products	92 & 93	Stocks	45
Fouling Scrapers	89	Stocks, Blanks	44
Fowler Rifle, Early	13	Tennessee Classic	33
Fowler, New England Club Butt	12	Tennessee Mountain	34
Gun Hangers	93	Thompson Center Fullstock	35
Gunsmithing Services 3, 62, 69, 70, 73, 81		Thompson Center Halfstock	35
Harpers Ferry Rifle	16	Thimbles	71 - 73
Hawken Fullstock	17	Toeplates	77
Hawken Halfstock	18	Touch Hole Liners	88
Inlays	82 & 83	Transitional Kentucky	36
Jaeger Rifle	19	Trapper Pistol	37
Jags	87	Triggers	66 - 70
Kentucky Pistol	20	Triggers	59 - 61
Lancaster Rifle, Early	21	Tulle	38
Lancaster Rifle, Late	22	Underhammer, Arkansas	39
Lehigh County Rifle	23	Underhammer, H & A	40
Leman Fullstock	24	Underlugs	86
Leman Halfstock	25	Verner, A.	41
Locks	52 - 58	Vincent Halfstock	42
Mainspring Vise	91	Virginia	43
Measures	89	Pecatonica River Long Rifle Supply Company	
Nipples	90	P.O. Box 2791 • Rockford, IL 61132	
		Phone: 815-968-1995	
		sales@longrifles-pr.com • www.longrifles-pr.com	

Craftsmanship is a Big Concern at Pecatonica River Long Rifle Supply Company

We are located in a small midwestern city that prides itself on precision. Rockford, Illinois, is a machine tool center that got its industrial start in the fine furniture business. Its early settlers were craftsmen concerned about shaping fine wood and later they turned metal into machinery for parts in early aircraft and autos. Many of the descendants of those early craftsmen are still around, working with fine wood and modern metals. They maintain the same high standards. We don't build, sell or buy anything that does not reflect quality and those traditions of craftsmanship.

About Building a Rifle...

Each year brings more black powder enthusiasts into our sport. Many are seeking the special quality and appearance that go into a hand-crafted firearm. Some of these shooters and collectors decide to build their own guns.

Although some of us are better craftsmen than others, we share the goal of wanting the best results we can obtain. To help you reach that goal, Pecatonica River Long Rifle Supply Company is now able to offer several types of stocks in various stages of completion.

We are inletting selected types of stocks for certain components. We have selected these components carefully to ensure their quality, authenticity and the harmony of design and function.

We are not able to inlet for components other than those we have specified for particular styles of firearms.

We are not interested in mass production of firearm "kits". Our concern is the man interested in building a firearm representative of a particular historical period. The components we offer are certainly not the "only" parts you can use to assemble a rifle, shotgun or pistol. However, the ones we have selected will function safely and properly (when correct procedures are followed) and will result in an attractive gun, when assembled with reasonable care and skill.

We operate on the premise that we are able to provide our customers with more quality than they might expect for their money. We seriously doubt if you can find a better stock than we supply and we suggest careful comparison before you purchase.

As we mentioned earlier "we are not interested in producing kits". They may be purchased with any or all of the suggested components. And our offerings are not supplied with instructions. Although relatively simple to assemble, with just a few common bench tools, we do suggest that you consider some fine books available on this subject before starting your project. Especially if this is your first rifle.

We do offer the book, "The Art of Building the Pennsylvania Long Rifle". This is one of the finest sources of information and technical instruction on the market today. It retails for \$25.00, but when purchased with a stock and complete components, we reduce the retail to \$15.00. It is the only book in our catalog.

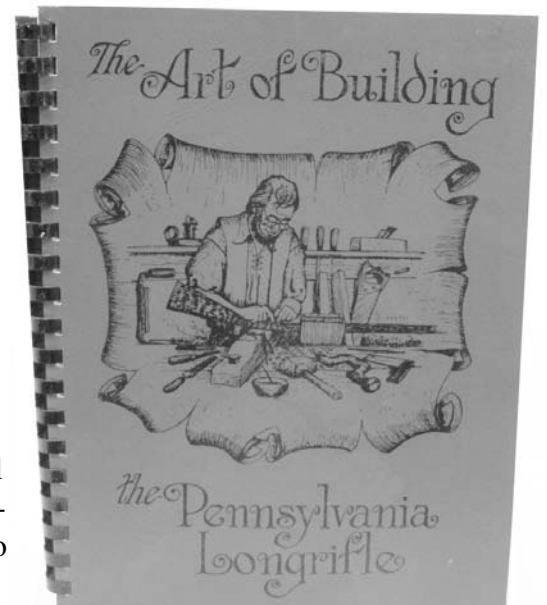

Important – Please Read

We advise reading our catalog thoroughly before placing your order. Many of your questions will be answered in it's pages. We are manufacturers and do not have a retail store. Our staff will do their best to answer your questions.

Inlet Stocks

We now have many stocks in this category. We cannot inlet for components other than those which we have specified for a particular style. It is impossible to change to a different make of lock or barrel size, etc., in the inlet stocks.

You may be assured that the components we have selected are correct and of high quality workmanship.

Selecting Wood for an Inlet Stock

With the introduction and great acceptance of our inlet stocks, we offer greater ease in building a fine rifle with investment potential. This has created some obstacles since many builders are now inclined to order higher grades of wood. We have not been able to purchase as much in the higher grades as orders call for, so please consider a second choice. We are constantly looking for higher grades. However, we are confident you will be satisfied since we do grade higher than most suppliers.

How to Order

Phone Orders:

815-968-1995 – our telephone line is open from 9:00 a.m. to 4:00 p.m. Monday thru Friday, Central Time. We are closed Saturdays and Sundays and all holidays.

Internet Web Site:

sales@longrifles-pr.com
www.longrifles-pr.com

Mail Orders:

Use the order form if available. Send order via United States Post Office to: Pecatonica River Long Rifle Supply Company, P.O. Box 2791, Rockford, IL 61132. If paying by personal check, allow 2 weeks for your check to clear.

Payment:

Express money order, bank draft or check. We accept Visa, MasterCard and Discover.

Postage and Handling:

Fullstocks or fullstocks and components- \$45.00
Halfstocks or halfstocks and components- \$30.00
Fullstocks no components- \$35.00
Halfstocks no components- \$25.00
Pistols- \$15.00
Barrels- \$20.00

Merchandise Totaling:

\$0 - \$50.00 = \$10.00
\$50.00 - \$100.00 = \$10.00

You will be advised of a back order and given approximate time of shipment or opportunity to cancel for a refund.

Order Form:

Our order form can be downloaded from our web site at www.longrifles-pr.com

Shipping:

Shipping charges will be added according to carrier and packaging requirements. We ship all our stocks by FedEx or U.S. mail. Shipping in the lower 48 contiguous states is primarily U.S. mail. All international shipping is by U.S. postal service only, according to their regulations whether surface or air mail. If at all possible, international orders are always shipped air mail & insured with the United States Postal Service.

FedEx Shipping losses will be replaced only if you follow these steps:

1. If a package is received in damaged condition, refuse it and notify FedEx. They will return the damaged package to us and we will reship.
2. If a loss or damage is found after package is opened, hold all items, packing and shipping boxes. Notify us. We will put in a claim and a FedEx Representative will contact you. When a claim number has been assigned, we will reship. Do not destroy packing or carton, as FedEx will not honor any claim if cartons cannot be inspected.

Returned Merchandise:

Any discrepancies in quality or grading will promptly be rectified, providing stock has not been altered in any way. If refund is desired, please contact us for shipping instructions.

Pecatonica Long Rifle Guarantee:

Our intent is to produce better than you expected. "Our standards are high." We try to provide wood which has been graded fairly and free of chips, cracks, knots, checks, rot or weak spots. We do not consider a slight mineral stain a defect, as most are completely unnoticeable on the finished gun.

We try to use good judgment in the customers' favor in selecting their stock. "We guarantee your satisfaction."

If you are in any way not satisfied, simply notify us at once within ten (10) days for shipping instructions for replacement or full refund. Guarantee is void if stock has been carved or inlet in any other way than it was received and may not be returned. Also we have no control over hidden defects.

Rifle Stock Prices

Our Maple is graded as follows:

	Halfstock	Fullstock
CM#1 or Straight Maple #1: Little or no curl in wood. 0 - 30% Curl	\$105.00	\$170.00
Curly Maple #2: Curly with occasional open areas. 35 - 60% Curl	\$120.00	\$190.00
Curly Maple #3: Curly throughout stock, possibly darker on one side. 70 - 85% curl	\$175.00	\$250.00
Curly Maple #4: Supreme, the finest curl and figure. 90 - 100% curl	\$215.00	\$325.00
Cherry or Walnut also available	\$160.00	\$235.00
Curly Maple #5	\$280.00	\$450.00
Premium Curly Ash - CM#1 or CM#2	\$140.00	\$210.00

Pistol Stock Prices

Straight Maple (or slight curl)	\$70.00	Walnut	\$85.00
CM#2 Curly Maple	\$85.00	CM#4 Curly Maple	\$110.00
Cherry	\$85.00	CM#5 Curly Maple	\$150.00

Pistol Stocks are all drilled for ramrod hole at no charge.

Gunsmithing Services

Install breech plug in barrel-plug is fitted tight against the inside shoulder of barrel with the tang against the barrel, \$25.00.

Install dovetail underlug, \$14.00 each.

Cut sight dovetails - 3/8" standard dovetails for front and rear sights, \$14.00 each.

Cut buttplate - rough fit buttplate to your length of pull, \$40.00

Install under rib w/screws and solder thimbles to rib, \$125.00

Cut and crown barrel, \$10.00

Drill and tap barrel for breech plug, \$30.00

Carve customers wood, full stock \$120.00, half stock \$95.00, pistol \$65.00

Install Nipple in Underhammer barrel \$20.00

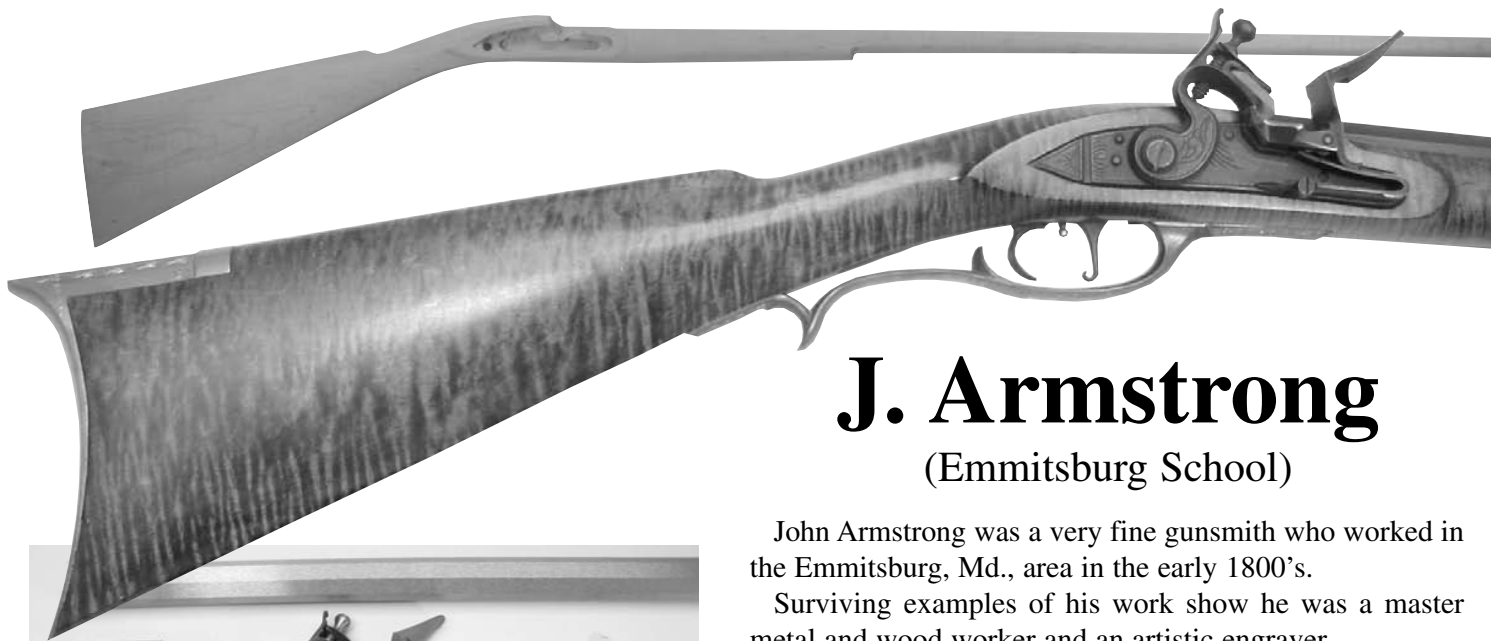

J. Armstrong

(Emmitsburg School)

John Armstrong was a very fine gunsmith who worked in the Emmitsburg, Md., area in the early 1800's.

Surviving examples of his work show he was a master metal and wood worker and an artistic engraver.

Armstrong built rifles of only the best available materials of his time. His long and slender guns were marked by a prominent comb, and his carving is distinguished by an unusual attention to detail and a flowing series of C-scrolls. Armstrong produced detailed inlays and his patch boxes were beautifully engraved. He apparently preferred to work with good quality curly maple for stocks.

Armstrong's long rifles are shining examples of what the American Long Rifle can be.

Careful attention to detail, long and flowing lines, artistic stock carving and precise engravings combine to make this type rifle a work of art.

Armstrong's work offers a model - and a challenge - to modern craftsmen. To attempt to reproduce this style rifle you will need a variety of skills, and a stock and parts of the highest quality. The results should more than repay your investment.



Grn. Mountain Barrel	13/16" & 7/8" x 42"	\$225.00
Appropriate Lock	L&R Classic Flint	\$215.00
*Optional Lock	(L&R Classic Perc.	\$150.00)
Appropriate dbl. - set Trigger	Davis #4	\$65.00
Appropriate Breech Plug	Fantail	\$12.00
Recommended Buttplate	Brass	\$22.00
Recommended Triggerguard	Brass	\$22.00
Recommended Thimbles	Brass	\$24.00
Recommended Nose Cap	Brass	\$12.00
Lock Screws	(2)	\$3.50
Tang Screws	(1)	\$1.75
Rear Sight		\$10.00
Front Sight		\$8.00
Barrel Lugs	(3)	\$9.00
Barrel Keys (or Pins)	(3) Pins	N/C
Escutcheons	Brass (6)	\$6.00
Toe Plate	Brass	\$6.00
Sideplate	Brass	\$9.00
Touch Hole Liner		\$3.00
Drum & Nipple		*((\$8.00)
Ramrod Jag & Tip	Brass	\$4.75
Ramrod		\$4.50
*Optional Patchbox		*((\$42.00)
Misc. Screws		\$1.50
Stock Inletting & Drilling		\$57.50

Full Stock Prices: (Maple Grade)

Curly Maple #1	\$170.00
Curly Maple #2	\$190.00
Curly Maple #3	\$250.00
Curly Maple #4	\$325.00
Curly Maple #5	\$450.00
Cherry or Walnut	\$235.00

Parts Total:	\$721.50
Stock Price: (_____)	
Grand Total: _____	

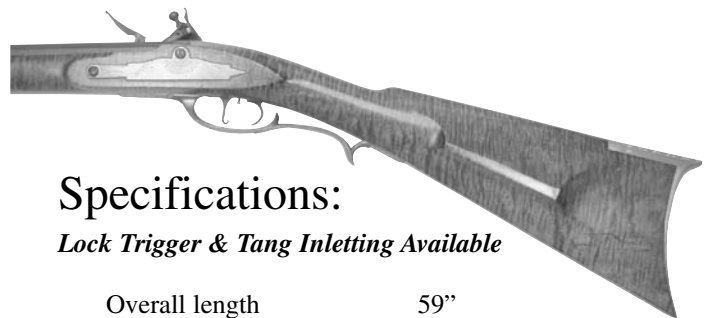

Specifications:

Lock Trigger & Tang Inletting Available

Overall length	59"
Pull length	16"
Drop at heel	3 3/4"
Barrel channel length	42"
Barrel channel size	13/16" and 7/8"
Ramrod hole size	3/8"
Lock mortice area	1-5/16" x 6-3/8"
Butt	1-9/16" x 5-1/4"

**Available with Colerain swamped barrel \$220.00. Additional \$65.00 inletting for swamped barrel. (Deduct price of original barrel).



Beck Boys Rifle

John Philip Beck was a well-known gunsmith of the Lebanon borough during the Revolution.

His work is thought to be representative of the "Lebanon School" and existing examples of his rifles show thick stocks with cheek pieces that rise high above the surrounding stock and feature molded edges. High attractive combs and flat, broad, Buttplates are characteristic.

Beck's rifles featured both brass and wooden Patchbox lids. They were often stocked with maple and the quality of wood ranged from good straight grain to an excellent curly stripe.

Although this rifle maker used silver inlays sparingly, at least one of his rifles included a double-headed eagle engraved on a silver inlay into the cheek piece. It was a work of art.

Beck was noted for his carving ability. His rifles usually featured detailed and flowing designs carved in high relief. His carvings in front of the cheek piece are somewhat standardized, but all of his wood work is excellent.

Beck patch boxes were often of a floral design and generally lightly, but carefully, engraved. Carvings were executed in front of the Patchbox and the box was released by a stud in the Buttplate on several of his rifles.

His ramrod pipes are shorter than those used by many other gunsmiths of the period, and the ends of the pipes are heavily molded. The muzzle caps of his rifles were fastened by three rivets placed in triangular form and two deep lines were often filed across the front part of the trigger guards of his guns.

These rifles also featured thick side plates with beveled edges.

A Beck rifle is a happy marriage of metal to wood, a joy to shoot and an object of artistry and craftsmanship that should reflect the pride of maker and owner.



Grn. Mountain Barrel	13/16" & 7/8" x 36"	\$225.00
Appropriate Lock	L&R Classic Flint	\$215.00
*Optional Lock	*(L&R Classic Perc.	\$150.00)
Appropriate dbl. - set Trigger	Davis #4	\$65.00
Appropriate Breech Plug	Fantail	\$12.00
Recommended Buttplate	Brass	\$22.00
Recommended Triggerguard	Brass	\$22.00
Recommended Thimbles	Brass (3)	\$24.00
Recommended Nose Cap	Brass	\$12.00
Lock Screws	(2)	\$3.50
Tang Screws	(1)	\$1.75
Rear Sight		\$10.00
Front Sight		\$8.00
Barrel Lugs	(3)	\$9.00
Barrel Keys (or Pins)	(3) Pins	N/C
Escutcheons	Brass (6)	\$6.00
Toe Plate	Brass	\$6.00
Sideplate	Brass	\$9.00
Touch Hole Liner		\$3.00
*Drum & Nipple		*(8.00)
Ramrod Jag & Tip	Brass	\$4.75
Ramrod		\$4.50
*Optional Patchbox		*(42.00)
Misc. Screws		\$1.50
Stock Inletting & Drilling		\$57.50

Full Stock Prices: (Maple Grade)

- Curly Maple #1 \$170.00
- Curly Maple #2 \$190.00
- Curly Maple #3 \$225.00
- Curly Maple #4 \$325.00
- Curly Maple #5 \$450.00
- Cherry or Walnut \$235.00

Parts Total:	\$721.50	(Flint)
Stock Price:	(_____)	
Grand Total:	_____	



Specifications:

Lock Trigger & Tang Inletting Available

Overall length	54"
Pull length	15"
Drop at heel	3-1/2"
Barrel channel length	36"
Barrel channel size	13/16" and 7/8"
Ramrod hole size	3/8"
Lock mortice area	6" x 1-1/4"
Width at lock	1-7/16"
Butt	4-7/16" x 1-1/2"



Bedford County

A distinguishing feature of the Bedford County Rifle is its length. These rifles tended to be quite long and were constructed on maple stocks of excellent quality. Numerous inlays of silver and brass decorated the length of the stock.

The rifles often used a patchbox of modified floral design held with six or seven screws. The barrel was pinned to the stock with three or four pins, depending on its length, and the pins were set through brass or silver inlays.

The cheek piece usually featured some inletting on this type rifle and almost all of the inlays included a certain amount of engraving.

Relief carving in a vine pattern that seems to cover and wind around the stock seems typical of rifles from this region. The butt seems to angle down from the wrist in a gradual slope.

The wood used for Bedford County Rifle stocks was always of the finest quality obtainable and carving and inlays highlighted the luster of the wood grain.

Some of the men who carried these rifles ranged through the Appalachian Mountains to open and settle new lands. The Bedford Rifle played an important part in the heritage of the families who settled this area. Hanging over a fireplace, it was an object of pride, and in the hands of its owner it was an important and efficient tool for survival.



Grn. Mountain Barrel	13/16" & 7/8"	\$225.00
Appropriate Lock	L&R Bedford Flint	\$215.00
*Optional Lock	*(L&R perc.	\$150.00)
Appropriate dbl. - set Trigger	Davis #4	\$65.00
Appropriate Breech Plug	Fantail	\$12.00
Recommended Buttplate	Brass	\$36.00
Recommended Triggerguard	Brass	\$38.00
Recommended Thimbles	Brass	\$24.00
Recommended Nose Cap	Brass	\$12.00
Lock Screws	(2)	\$3.50
Tang Screws	(1)	\$1.75
Rear Sight		\$10.00
Front Sight		\$8.00
Barrel Lugs	(3)	\$9.00
Barrel Keys (or Pins)	(3) Pins	N/C
Escutcheons	Brass (6)	\$6.00
Toe Plate	Brass	\$6.00
Sideplate	Brass	\$9.00
Touch Hole Liner		\$3.00
Drum & Nipple		*(8.00)
Ramrod Jag & Tip	Brass	\$4.75
Ramrod		\$4.50
*Optional Patchbox		*(42.00)
Misc. Screws		\$1.50
Stock Inletting & Drilling		\$57.50

Full Stock Prices: (Maple Grade)

Curly Maple #1	\$170.00
Curly Maple #2	\$190.00
Curly Maple #3	\$250.00
Curly Maple #4	\$325.00
Curly Maple #5	\$450.00
Cherry or Walnut	\$235.00

Parts Total:	\$751.50 (Flint)
Stock Price:	(_____)
Grand Total:	_____

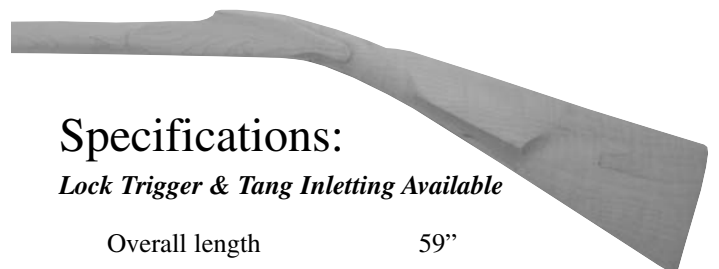

Specifications:

Lock Trigger & Tang Inletting Available

Overall length	59"
Pull length	15"
Drop at heel	4-1/2"
Barrel channel length	42"
Barrel channel size	13/16" and 7/8"
Ramrod hole size	5/16" or 3/8"
Lock mortice area	1-5/16" x 7-1/4"
Width at lock	1-5/8"
Butt	1-5/8" x 4-3/4"



The Blunderbuss

Introduced in Europe by the Dutch and Germans, the Blunderbuss was most popular in the British Isles between 1750 and 1850.

Gate guards and game keepers on private estates were armed with the Blunderbuss. It was equally as popular with highwaymen, street robbers and burglars. Dublin and London were neuters for its production.

In 1784 the Royal Mail Service was organized. A uniformed guard carried a brace of pistols as well as a Blunderbuss. The prescribed load was a charge of 10 to 12 shots the size of a pea. To ensure against misfires, the guns had to be reloaded once a week.

Growing law and order in the early 1800's brought steam engines, leading to trains, and by 1850 trains were leaving London at double the speed and a third of the price. The colorful ways of the road were vanishing. By 1850, the end had come for coaches, highwaymen and the Blunderbuss.

Specifications:

Overall length	36"
Pull length	14-1/2"
Drop at heel	2-1/2"
Barrel channel length	19-7/8"
Barrel channel size	1-1/8" at rear
Ramrod hole size	3/8"
Lock mortice area	7-1/4" x 1-9/16"
Width at lock	1-11/16"
Butt	1-3/4" x 5-1/8"



Walnut Stock	1-1/4" at Muzzle	\$235.00
Barrel	75 cal. 20" long, with Breechplug	\$295.00
Lock	L&R Queen Anne Flint	\$215.00
Trigger		\$30.00
Buttplate	Iron	\$28.00
Triggerguard	Iron	\$28.00
Thimbles		\$18.00
Lock Screws		\$3.50
Tang Screws		\$1.75
Barrel Lugs	(2)	\$6.00
Side Plate	Iron	\$8.00
Touch Hole Liner		\$3.00
Ramrod Jag & Tip		\$4.75
Ramrod		\$4.50
Misc. Screws		\$1.50
Stock Inletting		\$82.50
Stock & Parts Total:		\$964.50



4 Bore Blunderbuss

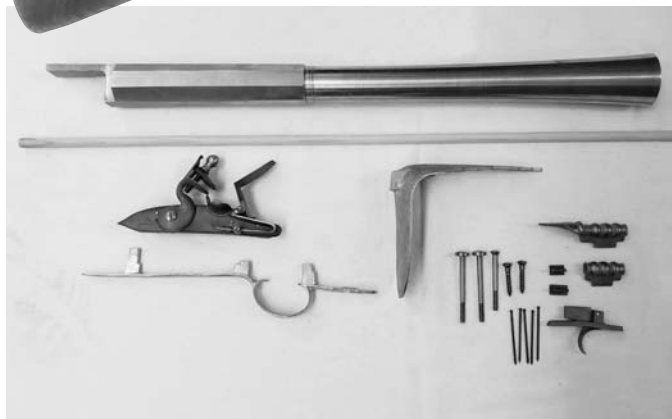

Introduced in Europe by the Dutch and Germans, the Blunderbuss was most popular in the British Isles between 1750 and 1850.

Gate guards and game keepers on private estates were armed with the Blunderbuss. It was equally as popular with highwaymen, street robbers and burglars. Dublin and London were neuters for its production.

In 1784 the Royal Mail Service was organized. A uniformed guard carried a brace of pistols as well as a Blunderbuss. The prescribed load was a charge of 10 to 12 shots the size of a pea. To ensure against misfires, the guns had to be reloaded once a week.

Growing law and order in the early 1800's brought steam engines, leading to trains, and by 1850 trains were leaving London at double the speed and a third of the price. The colorful ways of the road were vanishing. By 1850, the end had come for coaches, highwaymen and the Blunderbuss.

Walnut		\$235.00
Barrel 4 Bore Rice	20" long with Breechplug	\$485.00
Lock	Engraved Davis Flint Lock	\$210.00
Trigger		\$30.00
Buttplate	Iron	\$36.00
Side Plate	Iron	\$15.00
Barrel Lugs	(2)	\$6.00
Thimbles	Steel	\$35.00
Triggerguard		\$34.00
Touch Hole Liner		\$3.00
Ramrod Jag & Tip		\$4.75
Ramrod		\$4.50
Misc. Screws		\$1.50
Stock Inletting		\$95.00
Lock Screws	(2)	\$3.50
Tang Screws		\$1.75

Stock & Parts Total: \$1,206.50

Specifications:

Overall length	36"
Pull length	14-1/2"
Drop at heel	2-1/2"
Barrel channel length	19-7/8"
Barrel channel size	1-1/2" at rear
Ramrod hole size	3/8"
Lock mortice area	7-3/4" x 1-3/4"
Width at lock	2-3/16"
Butt	2-1/9" x 5-1/8"



10 Bore Blunderbuss

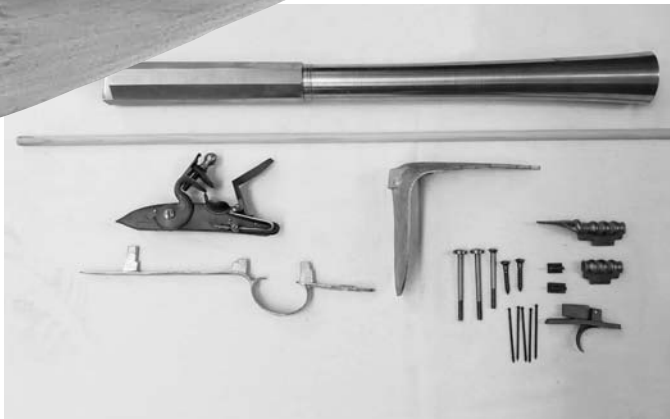

Introduced in Europe by the Dutch and Germans, the Blunderbuss was most popular in the British Isles between 1750 and 1850.

Gate guards and game keepers on private estates were armed with the Blunderbuss. It was equally as popular with highwaymen, street robbers and burglars. Dublin and London were neuters for its production.

In 1784 the Royal Mail Service was organized. A uniformed guard carried a brace of pistols as well as a Blunderbuss. The prescribed load was a charge of 10 to 12 shots the size of a pea. To ensure against misfires, the guns had to be reloaded once a week.

Growing law and order in the early 1800's brought steam engines, leading to trains, and by 1850 trains were leaving London at double the speed and a third of the price. The colorful ways of the road were vanishing. By 1850, the end had come for coaches, highwaymen and the Blunderbuss.

Walnut	1-15/16 at Muzzle	\$235.00
Barrel 10 Bore Rice	20" long with Breechplug	\$485.00
Lock	Engraved Davis Flint Lock	\$215.00
Trigger		\$30.00
Buttplate	Iron	\$36.00
Side Plate	Iron	\$15.00
Barrel Lugs	(2)	\$6.00
Thimbles	Steel	\$35.00
Triggerguard		\$34.00
Touch Hole Liner		\$3.00
Ramrod Jag & Tip		\$4.75
Ramrod		\$4.50
Misc. Screws		\$1.50
Stock Inletting		\$95.00
Lock Screws	(2)	\$3.50
Tang Screws		\$1.75

Stock & Parts Total: \$1,206.50

Specifications:

Overall length	36"
Pull length	14-1/2"
Drop at heel	2-1/2"
Barrel channel length	19-7/8"
Barrel channel size	1-1/2" at rear
Ramrod hole size	3/8"
Lock mortice area	7-3/4" x 1-3/4"
Width at lock	2-3/16"
Butt	2-1/9" x 5-1/8"

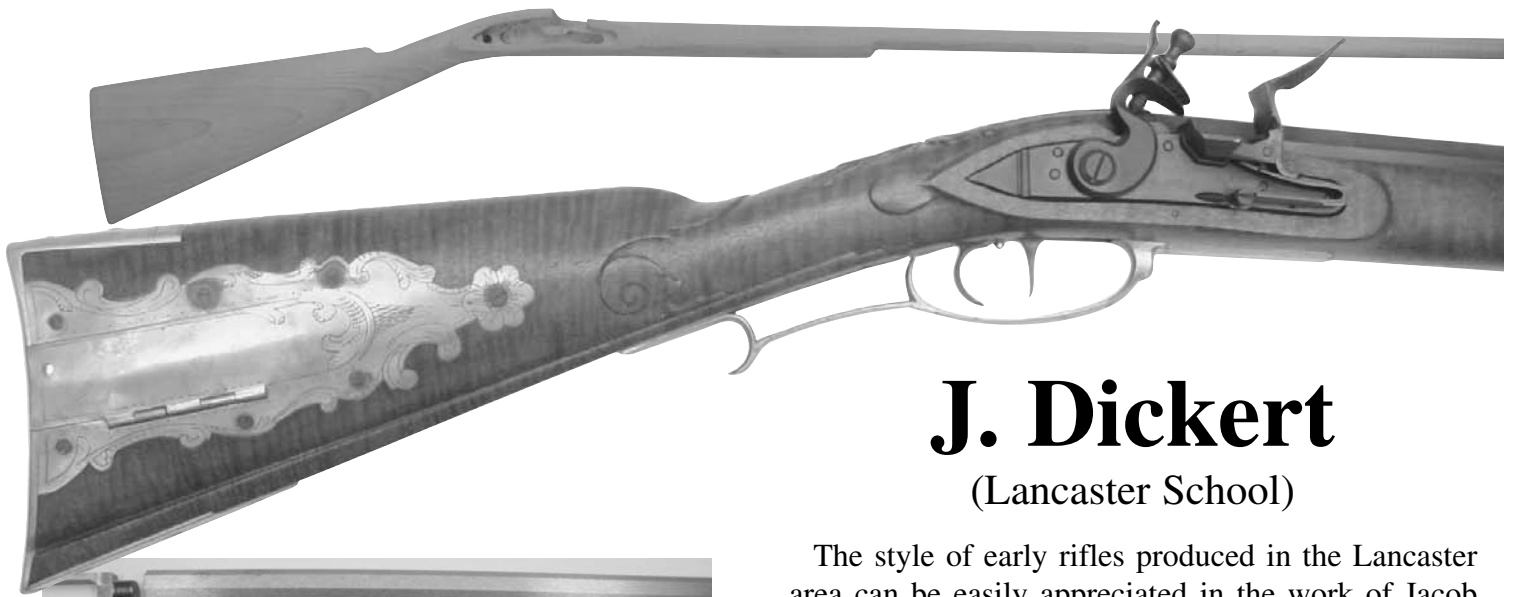

J. Dickert

(Lancaster School)

The style of early rifles produced in the Lancaster area can be easily appreciated in the work of Jacob Dickert. This master gunsmith came to America around 1750, and produced rifles for the Continental Army after becoming a citizen.

Dickert was an influential gun builder who is credited by some authorities with giving direction to the development of the Kentucky Rifle.

The examples of his work that survive are very few, but there are indications he favored a relatively simple design. He used both incised and relief carvings and patchboxes were daisy-style and engraved. His boxes seem to have been marked with a design that looks like three adjoining mounds worked on the edge of the box nearest the hinge.

Dickert's rifles were sturdy, about five feet long, and about nine pounds in weight. The rifles were thick stocked and included a flat Buttplate and high comb.



Specifications:

Lock Trigger & Tang Inletting Available

Overall length	59"
Pull length	15"
Drop at heel	3-1/4"
Barrel channel length	42"
Barrel channel size	13/16" and 7/8"
Ramrod hole size	3/8"
Lock mortice area	1-5/16" x 7"
Width at lock	1-1/2"
Butt	2" x 5"

** Available with Colerain swamped barrel \$220.00. Additional \$65.00 inletting for swamped barrel. (Deduct price of original barrel).

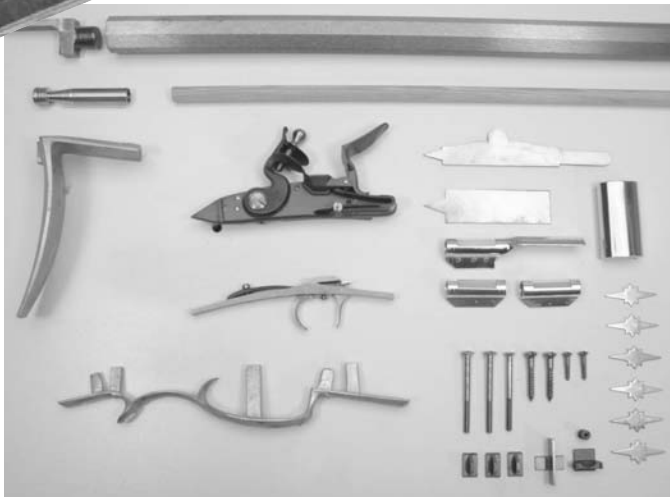

Grn. Mountain Barrel	13/16" & 7/8" x 42"	\$225.00
Appropriate Lock	L&R Classic Flint	\$215.00
*Optional Lock	*(L&R Classic Perc.	\$150.00)
Appropriate dbl. - set Trigger	Davis #4	\$65.00
Appropriate Breech Plug	Fantail	\$12.00
Recommended Buttplate	Brass	\$36.00
Recommended Triggerguard	Brass	\$36.00
Recommended Thimbles	Brass (3)	\$24.00
Recommended Nose Cap	Brass	\$12.00
Lock Screws	(2)	\$3.50
Tang Screws	(1)	\$1.75
Rear Sight		\$10.00
Front Sight		\$8.00
Barrel Lugs	(3)	\$9.00
Barrel Keys (or Pins)	(3) Pins	N/C
Escutcheons	Brass (6)	\$6.00
Toe Plate	Brass	\$6.00
Sideplate	Brass	\$9.00
Touch Hole Liner		\$3.00
Drum & Nipple		*((\$8.00)
Ramrod Jag & Tip	Brass	\$4.75
Ramrod		\$4.50
*Optional Patchbox		*((\$54.00)
Misc. Screws		\$1.50
Stock Inletting & Drilling		\$57.50

Full Stock Prices: (Maple Grade)

Curly Maple #1	\$170.00
Curly Maple #2	\$190.00
Curly Maple #3	\$250.00
Curly Maple #4	\$325.00
Curly Maple #5	\$450.00
Cherry or Walnut	\$235.00

Parts Total:	\$749.50 (Flint)
Stock Price:	(_____)
Grand Total:	_____

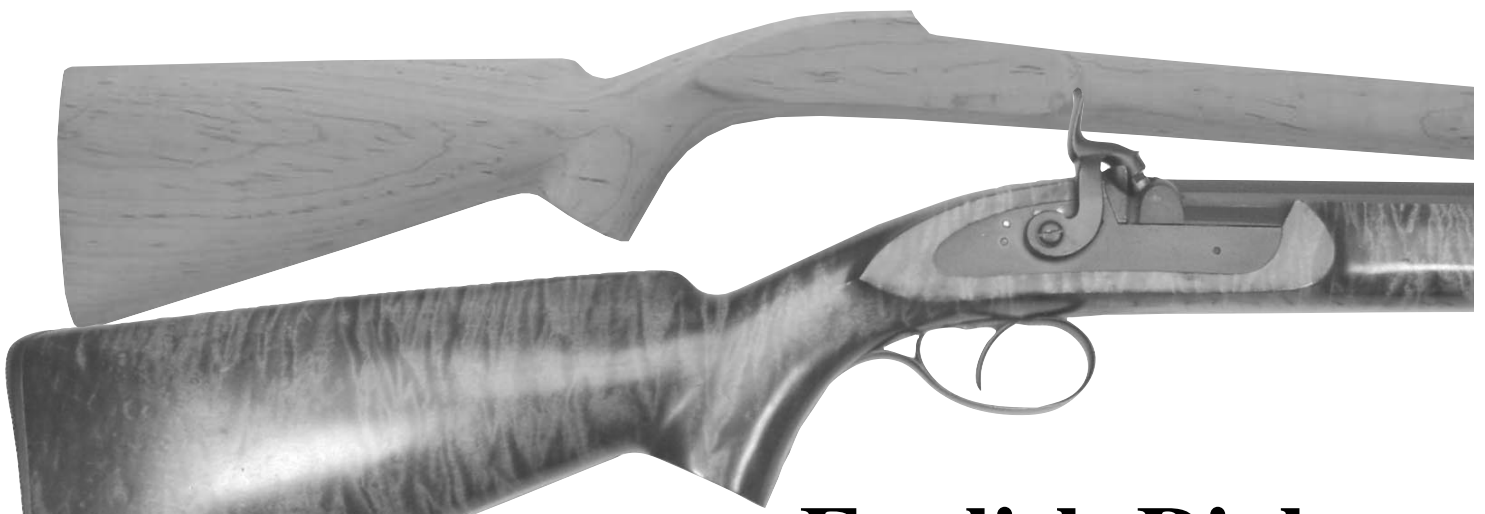

English Rigby Sporting Rifle

John Rigby advanced the design of firearms by including all of the best features known in his day. These rifles were purchased by match competitors and were used in international competition. Most commonly used were walnut stocks. The classic pistol grip and wide checkered Buttplate are designed to aid the shooter during competition. Hooked breech plug and tang allow the barrel to be removed for easy cleaning. No ramrod, ramrod pipes, or barrel rib are included. Loading and cleaning rods are used at the loading bench. Sights are not included. A vernier tang sight and windgauge front sight should be used for optimum accuracy.

Grn. Mountain Barrel	1" x 34"	\$225.00
Appropriate Lock	L&R Bar Perc.	\$150.00
English Bar		\$10.00
Single Trigger		\$30.00
Appropriate Breech Plug	English Hook	\$75.00
Recommended Buttplate	Checkered Steel	\$29.00
Recommended Triggerguard	Steel	\$29.00
Recommended Thimbles		(none)
Recommended Nose Cap		(none)
Lock Screws	(1)	\$1.75
Tang Screws	(1)	\$1.75
Barrel Rib		(none)
Rear Sight		(none)
Front Sight		(none)
Barrel Lugs	(1)	\$6.00
Barrel Keys (or Pins)	(1)	\$6.00
Escutcheons	(2)	\$10.00
Lock Bolt Inlay		\$6.00
Nipple		\$3.00
Ramrod Jag & Tip		(none)
Ramrod		(none)
*Optional Patchbox		(none)
Misc. Screws		\$1.50
Stock Inletting & Drilling		\$57.50

Half Stock Prices: (Maple Grade)		\$641.50
Curly Maple #1		\$105.00
Curly Maple #2		\$120.00
Curly Maple #3		\$175.00
Curly Maple #4		\$215.00
Curly Maple #5		\$280.00
Cherry or Walnut		\$160.00
Parts Total:		
Stock Price: (_____)		
Grand Total: _____		



Specifications:

Lock Trigger & Tang Inletting Available

Overall length	28-1/2"
Pull length	15"
Drop at heel	2-1/2"
Barrel channel length	12"
Barrel channel size	1"
Ramrod hole size	Optional
Lock mortice area	1-3/4" x 7"
Width at lock	1-3/4"
Butt	2" x 5-3/8"



New England Club Butt Fowler

The gunsmiths of 18th Century New England were inspired by the French Buccaneer guns of the late 17th Century where they adopted this style to their fowlers and rifles. The Club Butt guns were made in New England from about 1700 to the 1830's with little change to the design.

Many have been converted to percussion in the 19th Century. These are a graceful design, light weight and come up and hold very well. They make an excellent gun for hunting as well as a very competitive smoothbore shooter.

These Fowlers can be made with or without the following: Butt Plate, Side Plate, Trigger Plate, Entry Plate.

There is also the option of having the tang screw come up from the bottom as on a Trade gun. Or any combination of these parts will make for a period correct Club Butt Fowler.

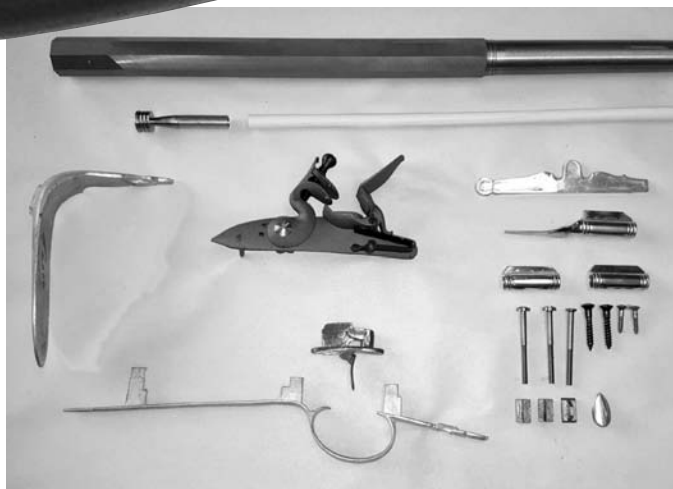

Barrel .20 ga.	1" Octagon to Round	\$275.00
Appropriate Lock	L&R Queen Anne	\$215.00
Appropriate Trigger	-	\$30.00
Appropriate Breech Plug	With Barrel	-
Recommended Buttplate	Steel	\$28.00
Recommended Triggerguard	Steel	\$28.00
Recommended Thimbles	(3)	\$24.00
Recommended Nose Cap	(none)	-
Lock Screws	(2)	\$3.50
Tang Screws	(1)	\$1.75
Rear Sight	(none)	-
Front Sight		\$12.00
Barrel Lugs	(3)	\$9.00
Barrel Keys (or Pins)	(3) Pins	N/C
Escutcheons	(none)	-
Toe Plate	(none)	-
Sideplate	-	\$15.00
Touch Hole Liner		\$3.00
Ramrod Jag & Tip		\$4.75
Ramrod		\$4.00
Misc. Screws		\$1.50
Stock Inletting & Drilling		\$82.50

Incl. Barrel Inlet & Buttplate Cut Barrel Breeched

Full Stock Prices: (Maple Grade)	Parts Total:	\$739.50
Curly Maple #1 \$170.00	Stock Price: (_____)	
Curly Maple #2 \$190.00	Grand Total: _____	
Curly Maple #3 \$250.00		
Curly Maple #4 \$325.00		
Curly Maple #5 \$450.00		
Cherry or Walnut \$235.00		

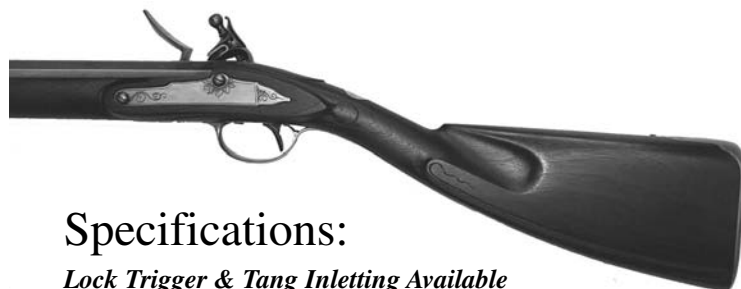

Specifications:

Lock Trigger & Tang Inletting Available

Overall length	58"
Pull length	15"
Drop at heel	3"
Barrel channel length	42"
Barrel channel size	3/4" round or out to round
Ramrod hole size	3/8"
Lock mortice area	7" x 1-1/2"
Butt	4-3/4" x 1-7/8"

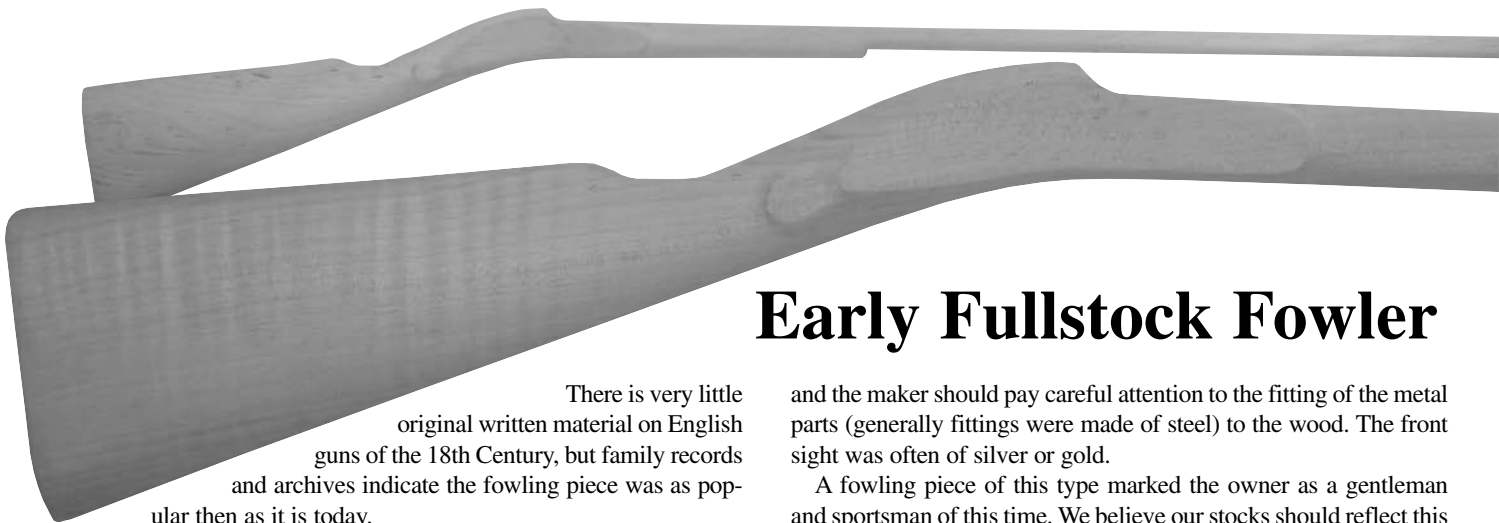

Early Fullstock Fowler

There is very little original written material on English guns of the 18th Century, but family records and archives indicate the fowling piece was as popular then as it is today.

Some of the finest examples of these guns included relief carvings along the stock, engraving along the lock and an occasional inlay of silver. Some of these also had wire inlays.

There are examples of both single and double barreled early fowling pieces, but the single is probably best known and was the model for the Northwest Trade Gun.

There is little resemblance between the trade guns and their more illustrious ancestors. It should be remembered that hunting in England was a pastime reserved for those who could afford land and many of these were nobility.

Their fowling pieces, like their other prized possessions, reflected their wealth and status. Barrels for these guns came from Italy and Spain and examples of these carefully carved shotguns can still be found bearing the name of prominent Italian craftsmen of the period. This is not because there were not satisfactory barrels being produced in England at the time, rather it was probably a novelty that "gentlemen" of the period enjoyed – the purchase of a fine barrel during their travels through continental Europe.

The stock for these fowlers should be made of high-quality wood

and the maker should pay careful attention to the fitting of the metal parts (generally fittings were made of steel) to the wood. The front sight was often of silver or gold.

A fowling piece of this type marked the owner as a gentleman and sportsman of this time. We believe our stocks should reflect this fine tradition.



Specifications:

Lock Trigger & Tang Inletting Available

Overall length	60"
Pull length	16"
Drop at heel	3-3/4"
Barrel channel length	42"
Barrel channel size	3/4"
Ramrod hole size	3/8"
Lock mortice area	1-1/2" x 7-1/2"
Width at lock	1-7/8"
Butt	2" x 5-1/2"

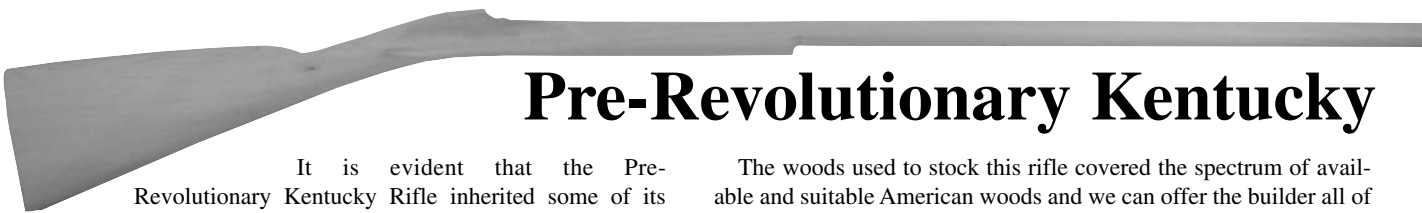

Pre-Revolutionary Kentucky

It is evident that the Pre-Revolutionary Kentucky Rifle inherited some of its lines from the German rifle, and still others from the early English fowling piece.

These rifles lacked the wooden sliding Patchbox (the Patchbox was a feature borrowed from the German rifle). The brass Patchbox lid on later rifles was purely an American innovation.

Many times these early guns were built from English or German locks, barrels, and other various gun parts. As European arms brought to America from the old countries were worn out with heavy use, the parts worth salvaging went into the American rifles that were to become the Pre-Revolutionary Kentucky.

These are truly interesting pieces, and it is apparent each new season that interest in this type of rifle is increasing.

Some of these guns had a rather short barrel but others had barrels almost four feet long. The barrels were full round, octagonal, or octagonal to round combinations.

Locks were generally large and single triggers were used. Trigger guards ranged from a martial type to the English fowler guards.

The cheek piece was often distinct and it became a mark of the typical Kentucky. The Buttplate was generally large.

The woods used to stock this rifle covered the spectrum of available and suitable American woods and we can offer the builder all of the types shown on our listing. We will also supply a piece of matching wood for a Patchbox if desired – although most of these rifles sported the brass hinged Patchbox lid.



Specifications:

Lock Trigger & Tang Inletting Available

Overall length	59"
Pull length	15-1/2"
Drop at heel	2-1/2"
Barrel channel length	42"
Barrel channel size	7/8", 15/16", 3/4"
Ramrod hole size	3/8"
Lock mortice area	1-1/2" x 7 "
Width at lock	1-3/4"
Butt	2" x 5-1/2"



English Shot Gun

The English single-barrel shotgun was a gentleman's firearm – and "London-made" stamped atop the barrel was a sign that it was top of the line. "London" meant quality to many buyers.

But "London" was just a place for some makers both in the U.S. and abroad. And even some of the fine London gunmakers used parts produced in other places (Birmingham, for example, was a center for the manufacturing of gun parts before 1700). The practice of adding a "London" marking to a gun produced somewhere else was so widespread that in 1813, London gunsmiths wanted a law requiring English firearms to list their "real" makers name and address. Birmingham makers managed to defeat the proposal, claiming that they made most of the parts for the rifles and shotguns being produced and that the final assembly point was not important.

These parts were produced by fine craftsmen who

were not quick to reveal the secrets of their trade. The smooth working lock, easy trigger pull and quality barrel became a tradition of the English gun that continued even after machinery was introduced to produce these arms.

The basic form of the shotgun has undergone little change in the past 200 years and the minor changes generally reflect the builder, buyer or the times. (For example, after the Revolutionary period the Butts and Buttplates of both shotguns and rifles became somewhat narrower.)

These guns were the inspiration for a more ornamental style, and copiers were careful to use local decorations and designs in the building.

As ever, fine wood is the starting point for a fine shotgun and you should select a type of wood that reflects your personal tastes, the purposes to which the gun will be put and a historical period.

Specifications:

Lock Trigger & Tang Inletting Available

Overall length	27-1/2"
Pull length	14-1/2"
Drop at heel	4"
Barrel channel length	11-3/4"
Barrel channel size	1"
Ramrod hole size	Optional
Lock mortice area	1-3/4" x 6-3/4"
Width at lock	1-3/4"
Butt	1-3/4" x 4-7/8"



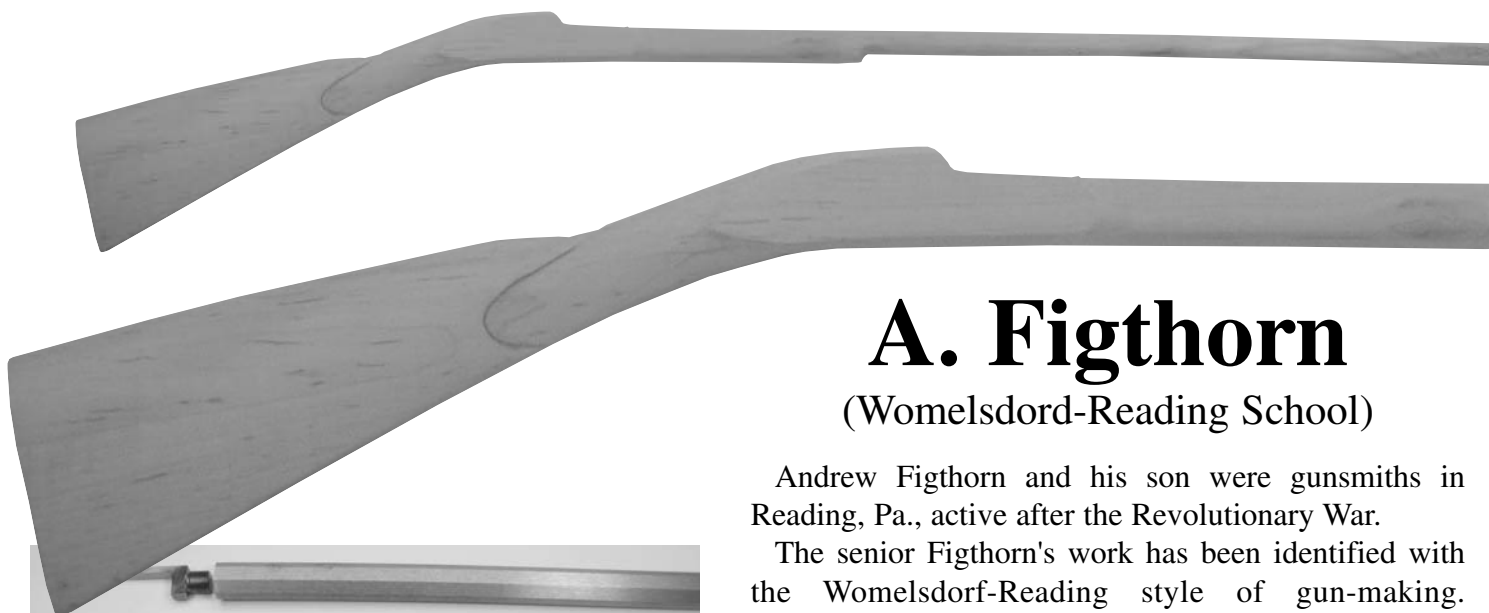

A. Figthorn

(Womelsdord-Reading School)

Andrew Figthorn and his son were gunsmiths in Reading, Pa., active after the Revolutionary War.

The senior Figthorn's work has been identified with the Womelsdorf-Reading style of gun-making. Characteristics include a patchbox release on the Buttplate, two round rivets that hold the patchbox catch and a small flange behind the forward sideplate screw.

Surviving examples of this work are stocked in a fine grade of curly maple. His stocks have a high comb and cheek piece and fine relief carving is generally found beneath the cheek piece.

Figthorn is noted for the quality of his relief carving and floral designs that extend from cheek piece to butt.

Patchbox designs seemed to vary, so a builder can create a very authentic appearance with any of several style boxes identified with this period. These were generally engraved. Some silver inlay work would also be authentic in style.

Andrew Figthorn was a talented and careful gunsmith who was generally faithful to the design of rifle that marks this period and area. A completed Figthorn-style rifle should be as pleasing to shoot as it is to the eye.



Grn. Mountain Barrel	13/16" & 7/8" x 42"	\$225.00
Appropriate Lock	L&R Classic Flint	\$215.00
*Optional Lock	*(L&R Classic Perc.	\$150.00)
Appropriate dbl. - set Trigger	Davis #4	\$65.00
Appropriate Breech Plug	Fantail	\$12.00
Recommended Buttplate	Brass	\$22.00
Recommended Triggerguard	Brass	\$22.00
Recommended Thimbles	Brass (3)	\$24.00
Recommended Nose Cap	Brass	\$12.00
Lock Screws	(2)	\$3.50
Tang Screws	(1)	\$1.75
Rear Sight		\$10.00
Front Sight		\$8.00
Barrel Lugs	(3)	\$9.00
Barrel Keys (or Pins)	(3) Pins	N/C
Escutcheons	Brass (6)	\$6.00
Toe Plate	Brass	\$6.00
Sideplate	Brass	\$9.00
Touch Hole Liner		\$3.00
Drum & Nipple		*((\$8.00)
Ramrod Jag & Tip	Brass	\$4.25
Ramrod		\$4.50
*Optional Patchbox		*((\$42.00)
Misc. Screws		\$1.50
Stock Inletting & Drilling		\$57.50

Full Stock Prices: (Maple Grade)

- Curly Maple #1 \$170.00
- Curly Maple #2 \$190.00
- Curly Maple #3 \$250.00
- Curly Maple #4 \$325.00
- Curly Maple #5 \$450.00
- Cherry or Walnut \$235.00

Parts Total:	\$721.25	(Flint)
Stock Price: (_____)		
Grand Total: _____		

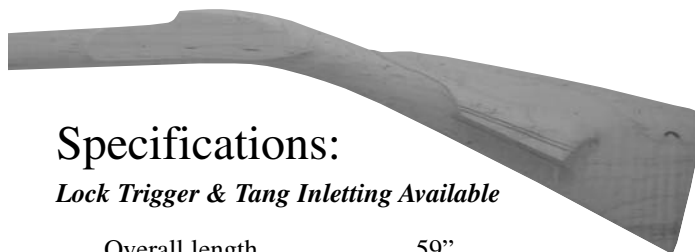

Specifications:

Lock Trigger & Tang Inletting Available

Overall length	59"
Pull length	15"
Drop at heel	3-7/8"
Barrel channel length	42"
Barrel channel size	13/16" and 7/8"
Ramrod hole size	3/8"
Lock mortice area	1-3/8" x 6-1/2"
Width at lock	1-5/8"
Butt	1-7/8" x 5-3/8"



Harpers Ferry Model 1803

This is the first official United States rifle adopted by this country, and probably the most graceful and beautiful rifle ever produced by a government arsenal. Built at the Harpers Ferry Arsenal from a prototype that Lewis and Clark wanted for their expedition through the west, this 1803 rifle has a 33" inch barrel with approximately 10-3/4" inch octagon with the balance of the barrel round. The lock is marked Harpers Ferry 1803 with a US stamped underneath an eagle. Walnut stock is shaped and inleted for barrel lock, trigger, patchbox and buttplate. This short barreled accurate rifle with tapered barrel was an advanced design well ahead of its time for a military rifle.



54 Cal. Oct. Round 33" Barrel		\$275.00
Appropriate Lock	Davis 1803 Flint	\$215.00
*Appropriate Trigger		\$30.00)
Appropriate Breech Plug	Installed in Bbl.	-
Recommended Buttplate	Brass	\$36.00
Recommended Triggerguard	Brass	\$36.00
Recommended Thimbles		\$34.00
Lock Screws	(2)	\$3.50
Tang Screws	(1)	\$1.75
Rear Sight		\$10.00
Barrel Rib -Milled		\$36.00
Front Sight		\$10.00
Barrel Lugs		\$6.00
Barrel Keys		\$6.00
Sideplate	Brass	\$8.00
Touch Hole Liner		\$3.00
Ramrod Jag		\$2.75
Ramrod 1/4" Flared Top		\$32.00
Brass Patchbox		\$35.00
Patchbox Release & Spring Kit		\$32.00
Misc. Screws		\$1.50
Stock Inletting & Drilling		\$72.50

Half Stock Prices: (Maple Grade)

- Curly Maple #1 \$105.00
- Curly Maple #2 \$125.00
- Curly Maple #3 \$175.00
- Curly Maple #4 \$215.00
- Curly Maple #5 \$280.00
- Cherry or Walnut \$160.00

Parts Total:	\$886.00
Stock Price: (_____)	
Grand Total: _____	



Specifications:

Lock Trigger & Tang Inletting Available

Barrel inlet	1-1/8" Oct. Round
Ramrod hole drilled for steel rod	
Barrel channel length	13-1/4"
Butt width	1-3/4" x 4-1/2"
Lock area	1-1/4" x 6-1/8"
Drop at heel	3"
Trigger pull	13-3/4"



Hawken Rifle

Fullstock



The word "Hawken" can start a lot of debates on the firing line or in a hunting cabin –but it wasn't always that way.

In the "shining times" of the fur trade almost every trapper and trader knew what a "Hawken" was and they valued these rifles highly in the western mountains.

John Baird, editor of "Buckskin Report" wrote a book entitled, "Hawken Rifles, the Mountain Man's Choice". The book was an obvious labor of love and is recommended reading for persons interested in building or owning a Hawken style rifle.

Baird probably took the title for his book from the marker over the grave of Samuel Hawken (1792-1884) which reads, "... the famous Hawken Rocky Mountain and Plains Rifle... for nearly half a century preceding the Civil War was the outstanding choice of the old mountain men, trappers and fur traders..."

There is much speculation about how the Hawken brothers decided on their rifle design. But most historians agree it was a rifle built and modified to meet the needs of its users. The early Harper's Ferry Rifle thought to have been carried by some of the members of the Lewis and Clark expedition might have played a part in the development of the early Hawken model. The first Hawkens were less stylized than later models and were Fullstocked. Later, the halfstock model, with full under rib, came to be recognized as a kind of trademark of the Hawken Brothers operations in St. Louis.

Some other common features of the Hawken, a one-piece trigger with scroll guard secured, and generally plain, iron-mounted furnishings - including toe plate and Buttplate.

Barrel	1" & 36"	\$225.00
Appropriate Lock	L&R Flint	\$215.00
*Optional Lock	(L&R Perc)	(\$150.00)
*Appropriate dbl. - set Trigger	(L&R)	(\$82.50)
*Optional Trigger System	(Davis)	(\$85.00)
Appropriate Breech Plug	L&R Flint	\$90.00
*Optional Breech System	(L&R Perc)	(\$90.00)
Recommended Buttplate	Iron	\$29.00
Recommended Triggerguard	Iron	\$29.00
Recommended Thimbles	Steel (3)	\$18.00
Recommended Nose Cap	Steel	\$13.00
Lock Screws	(2)	\$3.50
Tang Screws	(2)	\$3.50
Rear Sight		\$10.00
Front Sight		\$8.00
Barrel Lugs	(3)	\$18.00
Barrel Keys (or Pins)	(3)	\$18.00
Toe Plate	Steel	\$4.00
Lock Bolt Inlay	Steel (2)	\$12.00
Touch Hole Liner		\$3.00
*Nipple	(Nipple)	(\$3.00)
Ramrod Jag & Tip	Brass	\$4.75
Ramrod		\$4.50
*Optional Patchbox		(\$45.00)
Misc. Screws		\$1.50
Stock Inletting & Drilling		\$57.50

Full Stock Prices: (Maple Grade)
 Curly Maple #1 \$170.00
 Curly Maple #2 \$190.00
 Curly Maple #3 \$250.00
 Curly Maple #4 \$325.00
 Curly Maple #5 \$450.00
 Cherry or Walnut \$235.00

Parts Total: \$849.75 (Flint)
 Stock Price: (_____)
 Grand Total: _____

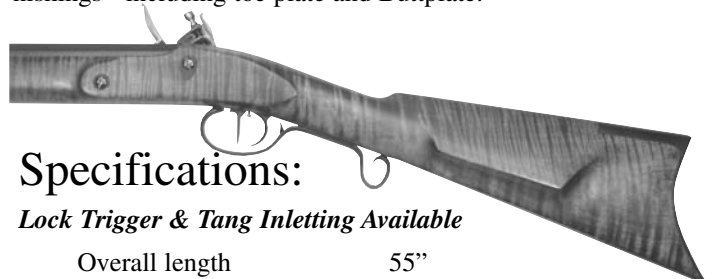

Specifications:

Lock Trigger & Tang Inletting Available

Overall length	55"
Pull length	15"
Drop at heel	3-3/4"
Barrel channel length	37"
Barrel channel size	15/16 & 1"
Ramrod hole size	3/8" & 7/16"
Lock mortice area	1-3/4" x 7"
Width at lock	1-13/16"
Butt	1-7/16" x 4-3/4"

Also available in left hand



Hawken Rifle Halfstock

The Patchbox is not a regular characteristic although surviving Hawkens with patchboxes have been found and some of these patch boxes were engraved. The rear sights were generally a slanting buck-horn type and the front was a silver blade. The rifles utilized a patent breech and .50 or .54 calibre seemed about standard. The stock was sturdy and some of the models favored extra wood where the forestock would rest on the pommel of a saddle. Hawkens built between 1830 and 1840 were often stocked with walnut.

In the next decade there was a move to more decorated rifles and this continued until after Jake Hawken's death in 1849. After that the surviving brother, Samuel, seemed to return to building a generally simpler and less decorative rifle.

Most of the Hawkens probably weighed about 10 or 11 pounds but there are some authentic 15 pounders around and some that weigh less than 10. If you have ever held an original Hawken you will appreciate the feel and "fit" of the rifle to the shoulder. Sighting is fast and tests show these rifles were very accurate. These are distinct advantages for the man whose survival often depended on getting off a good fast shot.

Generally the Hawken rifle seems rounded. Its curves flow and its lines are not harsh. (An excellent exhibit of these rifles can be found at the Buffalo Bill Museum in Cody, Wyoming). The wrist is usually egg-shaped, and in the early models, the stocks seem to be slightly arched in the comb with the hint of a Roman nose. In later models the top line of the comb seems to have been straightened.

The Hawken is another American firearm rich in tradition. If you intend to own or build one, you owe it to yourself and to your heritage to take the time to find out more about this unique rifle.



Grn. Mountain Barrel	1" & 36"	\$225.00
Appropriate Lock	L&R	\$150.00
Appropriate dbl. - set Trigger	L&R	\$82.50
*Optional Trigger System	(Davis)	(\$85.00)
Appropriate Breech Plug	L&R	\$90.00
Recommended Buttplate	Iron	\$29.00
Recommended Triggerguard	Iron	\$29.00
Recommended Thimbles	Steel (3)	\$18.00
Recommended Nose Cap	Steel	\$13.00
Lock Screws	(1)	\$1.75
Tang Screws	(2)	\$3.50
Barrel Rib		\$36.00
Rear Sight		\$10.00
Front Sight		\$8.00
Barrel Lugs	(2)	\$12.00
Barrel Keys	(2)	\$12.00
Escutcheons	(4)	\$8.00
Toe Plate	Steel	\$4.00
Lock Bolt Inlay	Steel	\$6.00
Nipple		\$3.00
Ramrod Jag & Tip	Brass	\$4.75
Ramrod		\$4.50
*Optional Patchbox		(\$45.00)
Misc. Screws		\$1.50
Stock Inletting & Drilling		\$57.50

Half Stock Prices: (Maple Grade)
 Curly Maple #1 \$105.00
 Curly Maple #2 \$125.00
 Curly Maple #3 \$175.00
 Curly Maple #4 \$215.00
 Curly Maple #5 \$280.00
 Cherry or Walnut \$160.00

Parts Total: \$805.00 (Perc)
 Stock Price: (_____)
 Grand Total: _____

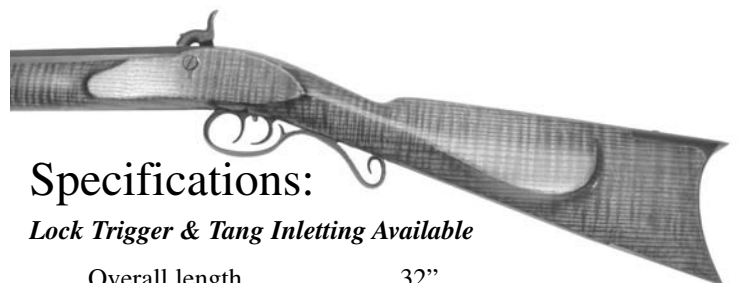

Specifications:

Lock Trigger & Tang Inletting Available

Overall length	32"
Pull length	15-1/2"
Drop at heel	3-1/4"
Barrel channel length	15"
Barrel channel size	15/16, 1" & 1-1/8"
Ramrod hole size	3/8" & 7/16"
Lock mortice area	1-3/4" x 7"
Width at lock	1-3/4"
Butt	1-3/16" x 5-3/16"



The Jaeger

There is disagreement about why the Jaeger (pronounced Yay-gur or Jay-gur) rifle is so named.

Some contend that the rifle's name has its origins in the German word for "hunter," and when the rifle came to the New World it was known as a hunter's rifle – a Jaeger rifle.

There also is a Jaeger gull that lives in the northern regions of the world. It is called the hunting gull. Some stories indicate the rifle got its name because of its gull neck-shaped wrist.

Although the origins of its name are uncertain, we can be sure that this rifle had great influence on American gunsmiths and builders of Pennsylvania and Kentucky Rifles.

When you first look at our gunstock it might appear too heavy and unwieldy, but a carefully finished Jaeger Rifle will become one of your proudest possessions. These guns reflect a solid and functional beauty that can be appreciated centuries after their design was introduced.

The most often used wood for original stocks was European walnut, but we have seen originals that were stocked with cherry and maple, as well as walnut.

The finishes on the Jaeger varied. Some were left bright and the barrels were polished, others were blued or blacked and some were browned (rust finished).

This firearm represents the start of America's "golden age" of rifle building. It is an excellent addition to the a collection and with craftsmanship and appropriate parts will be an excellent shooting rifle.



Specifications:

Lock Trigger & Tang Inletting Available

Overall length	53"
Pull length	14-1/2"
Drop at heel	3-1/4"
Barrel channel length	36"
Barrel channel size	1 or 3/4"
Ramrod hole size	7/16"
Lock mortice area	1-3/8" x 7"
Width at lock	1-3/4"
Butt	2-1/4" x 5-1/4"

**Available with Rice swamped barrel \$225.00. Additional \$45.00 inletting for swamped barrel. (Deduct price of original barrel).



Barrel	1" & 36"	\$225.00
Appropriate Lock	Davis Jaeger Flint	\$210.00
Appropriate dbl. - set Trigger	Davis Jaeger	\$65.00
Appropriate Breech Plug	Fantail	\$12.00
Recommended Buttplate	Brass	\$36.00
Recommended Triggerguard	Brass	\$36.00
Recommended Thimbles	Brass (3)	\$48.00
Recommended Nose Cap	(none)	-
Lock Screws	(2)	\$3.50
Tang Screws	(1)	\$1.75
Rear Sight		\$12.00
Front Sight		\$9.00
Barrel Lugs	(3)	\$9.00
Barrel Keys (or Pins)	(3) Pins	N/C
Escutcheons	(none)	-
Toe Plate	(none)	-
Sideplate	Brass	\$23.00
Touch Hole Liner		\$3.00
Drum & Nipple	(none)	-
Ramrod Jag & Tip	Brass	\$4.75
Ramrod		\$4.50
*Optional Patchbox	(none)	-
Misc. Screws		\$1.50
Stock Inletting & Drilling		\$57.50

Full Stock Prices: (Maple Grade)

- Curly Maple #1 \$170.00
- Curly Maple #2 \$190.00
- Curly Maple #3 \$250.00
- Curly Maple #4 \$325.00
- Curly Maple #5 \$450.00
- Cherry or Walnut \$235.00

Parts Total:	\$761.50
Stock Price: (_____)	
Grand Total: _____	



Kentucky Pistol

The Kentucky pistol, like its big brother the Kentucky rifle, was a work of art and accuracy.

The original Kentucky pistols we have seen are generally of superb balance, made of excellent wood, and with a most dependable lock.

Some of these pistols are rather ornate with relief carving and brass and silver fittings. Wire inlays were sometimes used and pistols with checkering as well as relief carving can be seen in museums and private collections.

Perhaps the most important feature of the Kentucky is the balance and the stock. Your pistol may be rather plain and you may choose to inlay a brass or silver circle in the handle, behind the tang or at the end of the butt with an initial.

The key to the construction of this pistol is the fitting of wood to metal, and the fitting of the entire piece to your hand.

We would recommend building a pistol in the same type wood as your rifle stock and you might want to consider a pistol and rifle of the same calibre (particularly if its .45 or under) to avoid carrying two types of ball.



Grn. Mountain Barrel	13/16" or 7/8" x 11	\$125.00
Appropriate Lock	L&R Manton Flint	\$215.00
*Optional Lock	*(L&R perc.)	(\$150.00)
Appropriate Trigger	Single Trigger	\$28.00
Appropriate Breech Plug		\$12.00
Recommended Triggerguard	Brass	\$34.00
Recommended Thimbles	5/16" Brass (2)	\$18.00
Recommended Nose Cap	Brass	\$12.00
Lock Screws	(1)	\$3.50
Tang Screws	(1)	\$1.75
Rear Sight		\$10.00
Front Sight		\$8.00
Barrel Lugs	(1)	\$3.00
Barrel Keys (or Pins)	(1) Pins	N/C
Side Plate	(1)	\$9.00
Touch Hole Liner	(1)	\$3.00
Drum & Nipple		*(8.00)
Ramrod Jag & Tip	Brass	\$4.75
Ramrod		\$1.00
Misc. Screws		\$.50
Stock Inletting & Drilling	Lock Inletted	\$35.00

Pistol Stock Prices:
 Straight Maple \$70.00
 Curly Maple #4 \$110.00
 Curly Maple #5 \$150.00
 Cherry \$85.00
 Walnut \$85.00

Parts Total: \$489.50 (Flint)
 Stock Price: (_____)
 Grand Total: _____

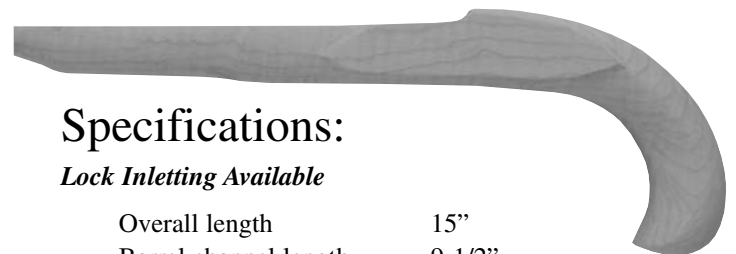

Specifications:

Lock Inletting Available

Overall length	15"
Barrel channel length	9-1/2"
Barrel channel size	13/16" and 7/8"
Lock mortice area	1-1/4" x 5-1/2"
Width at lock	1-3/8"
Ramrod hole size	15/16"



Early Lancaster

The Kentucky rifle was probably first produced in Lancaster County, Pennsylvania, during the Revolutionary War period – or even earlier.

The early Lancaster Rifle is a tribute to the craftsmanship and individual artistry of the period's gunsmiths, and surviving examples show a great concern with flowing lines and the fitting of wood to metal.

Most of these early rifles featured a heavier stock than used for the later period. The rifle's forestock was usually plain, with a high straight comb and a wrist extending far down toward the Buttplate.

The most common carvings along the stock were "C" scrolls, a design common to the 18th Century that can also be seen in period furniture.

A daisy-type Patchbox, with its lid fastened by three screws, makes most of these rifles easy to identify, but we have seen a few Lancasters with other floral patchbox designs. These may have reflected the individuality of the gunsmith and his client.

Since Lancaster was one of the biggest and most important rifle-making centers in early America, and since it is known that gunsmiths took their own and each other's sons on as apprentices, we can imagine the high degree of competitive craftsmanship that would have been reflected by the firearms of this period and region.



Specifications:

Lock Trigger & Tang Inletting Available

Overall length	59"
Pull length	15-1/2"
Drop at heel	3-1/2"
Barrel channel length	42"
Barrel channel size	15/16", 1"
Ramrod hole size	3/8", 7/16"
Lock mortice area	6-1/2" x 1-3/4"
Width at lock	1-3/4"
Butt	5-1/4" x 1-11/16"

**Available with swamped barrel \$220.00. Additional \$65.00 inletting for swamped barrel. (Deduct price of original barrel).



Grn. Mountain Barrel	15/16" & 1" x 42"	\$225.00
Appropriate Lock	L&R Classic Flint	\$215.00
*Optional Lock	*(L&R Classic Perc.)	(\$150.00)
Appropriate dbl. - set Trigger	Davis #4	\$65.00
Appropriate Breech Plug	Fantail	\$12.00
Recommended Buttplate	Brass	\$22.00
Recommended Triggerguard	Brass	\$22.00
Recommended Thimbles	Brass (3)	\$24.00
Recommended Nose Cap	Brass	\$12.00
Lock Screws	(2)	\$3.50
Tang Screws	(1)	\$1.75
Rear Sight		\$10.00
Front Sight		\$8.00
Barrel Lugs	(3)	\$9.00
Barrel Keys (or Pins)	(3) Pins	N/C
Escutcheons	Brass (6)	\$6.00
Toe Plate	Brass	\$6.00
Sideplate	Brass	\$9.00
Touch Hole Liner		\$3.00
Drum & Nipple		*(8.00)
Ramrod Jag & Tip	Brass	\$4.75
Ramrod		\$4.50
*Optional Patchbox		*(42.00)
Misc. Screws		\$1.50
Stock Inletting & Drilling		\$57.50

Full Stock Prices: (Maple Grade)

Curly Maple #1	\$170.00
Curly Maple #2	\$190.00
Curly Maple #3	\$250.00
Curly Maple #4	\$325.00
Curly Maple #5	\$450.00
Cherry or Walnut	\$235.00

Parts Total:	\$720.00 (Flint)
Stock Price:	(_____)
Grand Total:	_____



Late Lancaster

The early Lancaster Rifle used a good grade of maple, sometimes with a straight grain, but the later Lancasters exhibit a fine curly grain “tiger stripe” that makes a Kentucky rifle such a distinctive piece.

The side plates on these later rifles are flat and very narrow, sometimes engraved. They often have a pronounced arch under the edge.

The comb of the rifle is lower and there is less of a drop at the wrist.

Some of these Lancasters feature ornate relief wood carving and brass or silver inlays. The Patchbox is usually engraved and is held by eight screws or more in many of these guns.

Brass and silver inlays, cut into forms and then engraved are often used, with a hunter's star, an eagle, a fish or some patriotic design being among the most common.

These inlays, combined with careful engravings, the carving and the slim lines of the rifle itself make the Lancaster Rifle pleasing to the eye and a pleasure to hold.



Specifications:

Lock Trigger & Tang Inletting Available

Overall length	59"
Pull length	15-1/2"
Drop at heel	3-1/8"
Barrel channel length	42"
Barrel channel size	13/16" or 7/8"
Ramrod hole size	3/8"
Lock mortice area	6-3/8" x 1-1/2"
Width at lock	1-3/4"
Butt	6-1/4" x 1-3/8"

Also available in left hand

**Available with Colerain swamped barrel \$220.00. Additional \$65.00 inletting for swamped barrel. (Deduct price of original barrel).



Grn. Mountain Barrel	13/16" & 7/8" x 42"	\$225.00
Appropriate Lock	L&R Classic Flint	\$215.00
*Optional Lock	*(L&R Classic Perc.)	(\$150.00)
Appropriate dbl. - set Trigger	Davis #4	\$65.00
Appropriate Breech Plug	Fantail	\$12.00
Recommended Buttplate	Brass	\$36.00
Recommended Triggerguard	Brass	\$36.00
Recommended Thimbles	Brass (3)	\$24.00
Recommended Nose Cap	Brass	\$12.00
Lock Screws	(2)	\$3.50
Tang Screws	(1)	\$1.75
Rear Sight		\$10.00
Front Sight		\$8.00
Barrel Lugs	(3)	\$9.00
Barrel Keys (or Pins)	(3) Pins	N/C
Escutcheons	Brass (6)	\$6.00
Toe Plate	Brass	\$6.00
Lock Bolt Inlay	Brass	\$9.00
Touch Hole Liner		\$3.00
Drum & Nipple		*(8.00)
Ramrod Jag & Tip	Brass	\$4.75
Ramrod		\$4.50
*Optional Patchbox		*(42.00)
Misc. Screws		\$1.50
Stock Inletting & Drilling		\$57.50

Full Stock Prices: (Maple Grade)

- Curly Maple #1 \$170.00
- Curly Maple #2 \$190.00
- Curly Maple #3 \$250.00
- Curly Maple #4 \$375.00
- Curly Maple #5 \$450.00
- Cherry or Walnut \$235.00

Parts Total:	\$749.50 (Flint)
Stock Price:	(_____)
Grand Total:	_____



Lehigh County

Kentucky rifles from the Lehigh area of Pennsylvania were influenced by other makers and continued to show many of the "classic" Kentucky rifle features.

Stocks were generally of fine curly maple and when that could not be obtained the curl was often imitated by artificial means. A distinctive feature of these rifles is the broad-wrist - a detail present in early models of Kentucky rifles produced elsewhere but continued for some time in this area.

The Lehigh rifles commonly used the scroll designs carved in relief around the stock. The patchbox was similar to the Allentown rifles but the Lehigh makers incorporated more engravings and their design was more complex and ornate.

A good example of the workmanship from this area are the rifles of John Moll, Jr., whose rifles are depicted in several of the books on the Kentucky rifle.

Moll's work was often marked by careful and detailed carving behind the rear ramrod pipe.

The stocks we produce for this type rifle are historically accurate and correct. The maker who wants a little something "extra" from this period would do well to consider the Lehigh as a well-designed and interesting firearm that can take its place over the fireplace or on the firing line.

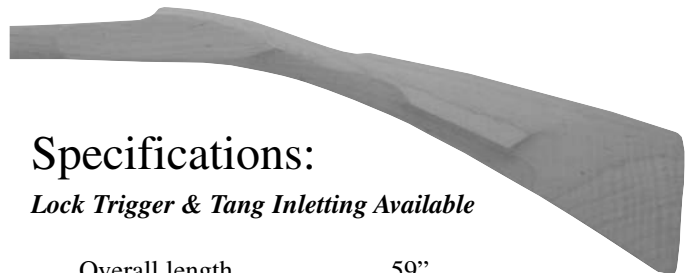

Specifications:

Lock Trigger & Tang Inletting Available

Overall length	59"
Pull length	16"
Drop at heel	5"
Barrel channel length	42"
Barrel channel size	13/16" and 7/8"
Ramrod hole size	3/8"
Lock mortice area	8" x 1-1/2"
Width at lock	1-9/16"
Butt	5" x 1-13/16"



Grn. Mountain Barrel	13/16" & 7/8" x 42"	\$225.00
Appropriate Lock	L&R DursE Flint	\$215.00
*Optional Lock	*(L&R perc.	\$150.00)
Appropriate dbl. - set Trigger	Davis #4	\$65.00
Appropriate Breech Plug	Fantail	\$12.00
Recommended Buttplate	Brass	\$22.00
Recommended Triggerrguard	Brass	\$22.00
Recommended Thimbles	Brass	\$24.00
Recommended Nose Cap	Brass	\$12.00
Lock Screws	(2)	\$3.50
Tang Screws	(1)	\$1.75
Rear Sight		\$10.00
Front Sight		\$8.00
Barrel Lugs	(3)	\$9.00
Barrel Keys (or Pins)	(3) Pins	N/C
Escutcheons	Brass (6)	\$6.00
Toe Plate	Brass	\$6.00
Sipe Plate	Brass	\$9.00
Touch Hole Liner		\$3.00
Drum & Nipple		*(8.00)
Ramrod Jag & Tip	Brass	\$4.75
Ramrod		\$4.50
*Optional Patchbox		*(24.00)
Misc. Screws		\$1.50
Stock Inletting & Drilling		\$57.50

Full Stock Prices: (Maple Grade)

Curly Maple #1	\$170.00
Curly Maple #2	\$190.00
Curly Maple #3	\$250.00
Curly Maple #4	\$325.00
Curly Maple #5	\$450.00
Cherry or Walnut	\$235.00

Parts Total:	\$745.50
Stock Price: (_____)	
Grand Total: _____	

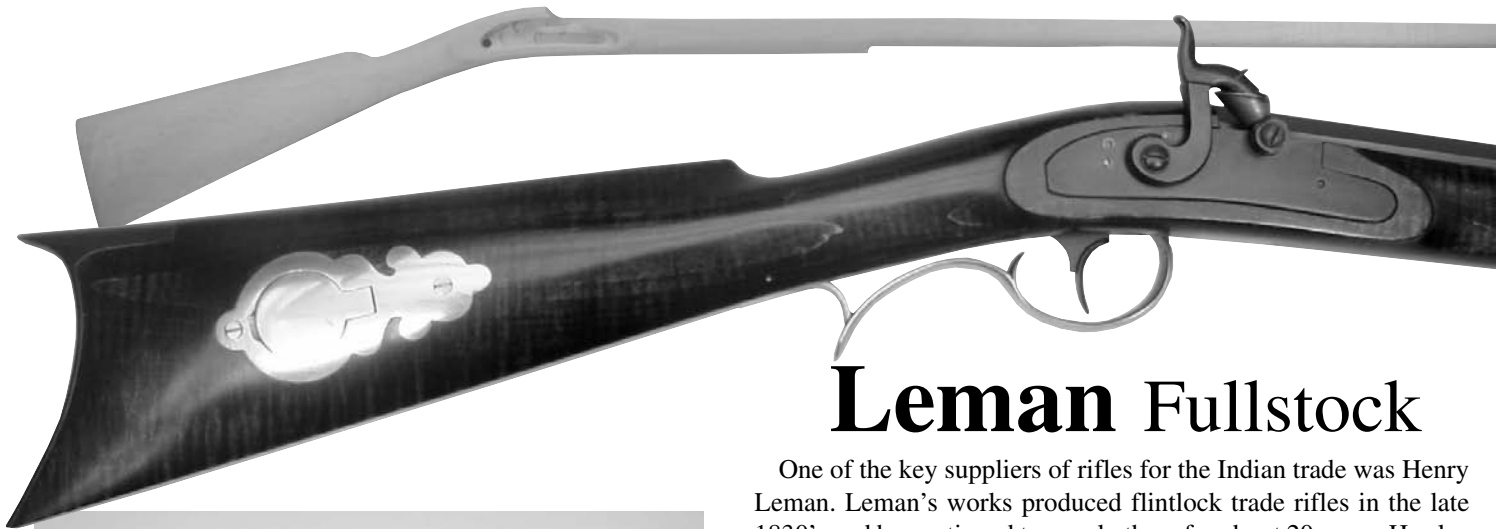

Lemman Fullstock

One of the key suppliers of rifles for the Indian trade was Henry Lemman. Lemman's works produced flintlock trade rifles in the late 1830's and he continued to supply them for about 20 years. He also produced large calibre percussion rifles for the Indian trade and even produced some of the Northwest guns during the middle of the 19th Century.

Lemman's trade rifles had a relatively short stock and they were built with both percussion and flint locks – although flint Lemmans seem more common.

Some of the rifles had a small Patchbox and these had a distinctive fleur-de-lis pointing up from the box itself. The rifles had a single-trigger and steel fittings – their use by the Indians required them to be rugged and dependable.

Many of Lemman's rifles found their way to the Indians since he gained several contracts to provide hunting rifles for Indians. These were produced in relatively large numbers on something like an assembly line.

That productivity may be why parts of Lemman guns occasionally turn up in odd places. A trapper or gunsmith sometimes might take an available Lemmans part to replace something on another gun that was broken. Lemman also provided some parts to other builders.

The modern builder might find this an excellent field or "meat" gun, particularly if careful attention is paid to fitting the stock to the individual's size and weight. We can provide a very good piece of wood and we recommend this be coupled with one of our fine barrels and a good lock – percussion or flint. A double-set trigger could be used and such a modification was probably made by some of the traders and trappers who owned one of Lemman's rifles.



Grn. Mountain Barrel	15/16" x 36"	\$225.00
Appropriate Lock	L&R Lemman perc.	\$150.00
Appropriate Trigger	Single Trigger	\$30.00
Appropriate Breech Plug		\$12.00
Recommended Buttplate	Brass	\$36.00
Recommended Triggerguard	Brass	\$36.00
Recommended Thimbles	Brass (3)	\$18.00
Recommended Nose Cap	Brass	\$12.00
Lock Screws	(1)	\$1.75
Tang Screws	(1)	\$1.75
Rear Sight		\$10.00
Front Sight		\$8.00
Barrel Lugs	(3)	\$9.00
Barrel Keys (or Pins)	(3) Pins	N/C
Escutcheons	(none)	-
Toe Plate	(none)	-
Lock Bolt Inlay		\$6.00
Drum & Nipple		\$8.00
Ramrod Jag & Tip		\$4.75
Ramrod		\$4.50
*Optional Patchbox	Brass	(\$45.00)
Misc. Screws		\$1.50
Stock Inletting & Drilling		\$57.50

Full Stock Prices: (Maple Grade)
 Curly Maple #1 \$170.00
 Curly Maple #2 \$190.00
 Curly Maple #3 \$250.00
 Curly Maple #4 \$325.00
 Curly Maple #5 \$450.00
 Cherry or Walnut \$235.00

Parts Total: \$631.75 (Perc.)
 Stock Price: (_____)
 Grand Total: _____

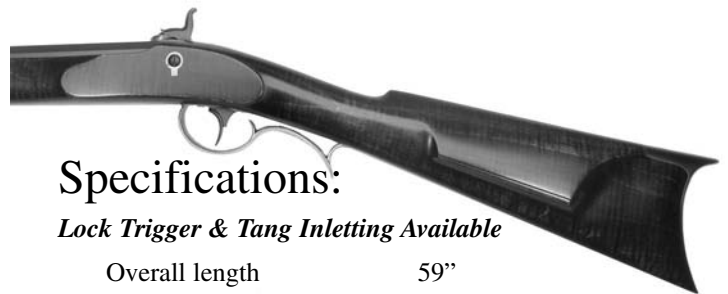

Specifications:

Lock Trigger & Tang Inletting Available

Overall length	59"
Pull length	15-1/2"
Drop at heel	4-1/2"
Barrel channel length	42"
Barrel channel size	15/16" and 1"
Ramrod hole size	3/8" and 7/16"
Lock mortice area	1-5/8" x 5-7/8"
Width at lock	1-7/8"
Butt	1-1/2" x 4-1/2"

Also available in left hand



Lemman Halfstock

One of the key suppliers of rifles for the Indian trade was Henry Lemman. Lemman's works produced flintlock trade rifles in the late 1830's and he continued to supply them for about 20 years. He also produced large calibre percussion rifles for the Indian trade and even produced some of the Northwest guns during the middle of the 19th Century.

Lemman's trade rifles had a relatively short stock and they were built with both percussion and flint locks, although flint Lemmans seem more common.

Some of the rifles had a small Patchbox and these had a distinctive fleur-de-lis pointing up from the box itself. The rifles had a single-trigger and steel fittings -their use by the Indians required them to be rugged and dependable.

Many of Lemman's rifles found their way to the Indians since he gained several contracts to provide hunting rifles for Indians. These were produced in relatively large numbers on something like an assembly line.

The modern builder might find this an excellent field or "meat" gun, particularly if careful attention is paid to fitting the stock to the individual's size and weight. We can provide a very good piece of wood and we recommend this be coupled with one of our fine barrels and a good lock - percussion or flint. A double-set trigger could be used and such a modification was probably made by some of the traders and trappers who owned one of Lemman's rifles.



Grn. Mountain Barrel	15/16" x 36"	\$225.00
Appropriate Lock	L&R Lemman perc.	\$150.00
Appropriate dbl. - set Trigger	Single Trigger	\$30.00
Appropriate Breech Plug		\$12.00
Recommended Buttplate	Brass	\$36.00
Recommended Triggerguard	Brass	\$36.00
Recommended Thimbles	(3)	\$18.00
Recommended Nose Cap	Brass	\$12.00
Lock Screws	(1)	\$1.75
Tang Screws	(1)	\$1.75
Barrel Rib		\$36.00
Rear Sight		\$10.00
Front Sight		\$8.00
Barrel Lugs	(1)	\$3.00
Lock Bolt Inlay		\$6.00
Drum & Nipple		\$8.00
Ramrod Jag & Tip		\$4.75
Ramrod		\$4.50
*Optional Patchbox	Brass	(\$45.00)
Misc. Screws		\$1.50
Stock Inletting & Drilling		\$57.50

Half Stock Prices: (Maple Grade)

- Curly Maple #1 \$85.00
- Curly Maple #2 \$100.00
- Curly Maple #3 \$155.00
- Curly Maple #4 \$195.00
- Curly Maple #5 \$260.00
- Cherry or Walnut \$140.00

Parts Total:	\$661.75	(Perc.)
Stock Price:	(_____)	
Grand Total:	_____	



Specifications:

Lock Trigger & Tang Inletting Available

Overall length	32"
Pull length	15"
Drop at heel	3-3/4"
Barrel channel length	15-1/4"
Barrel channel size	15/16" and 1"
Ramrod hole size	3/8" and 7/16"
Lock mortice area	1-5/8" x 6"
Width at lock	1-3/4"
Butt	1-1/2" x 4-1/2"

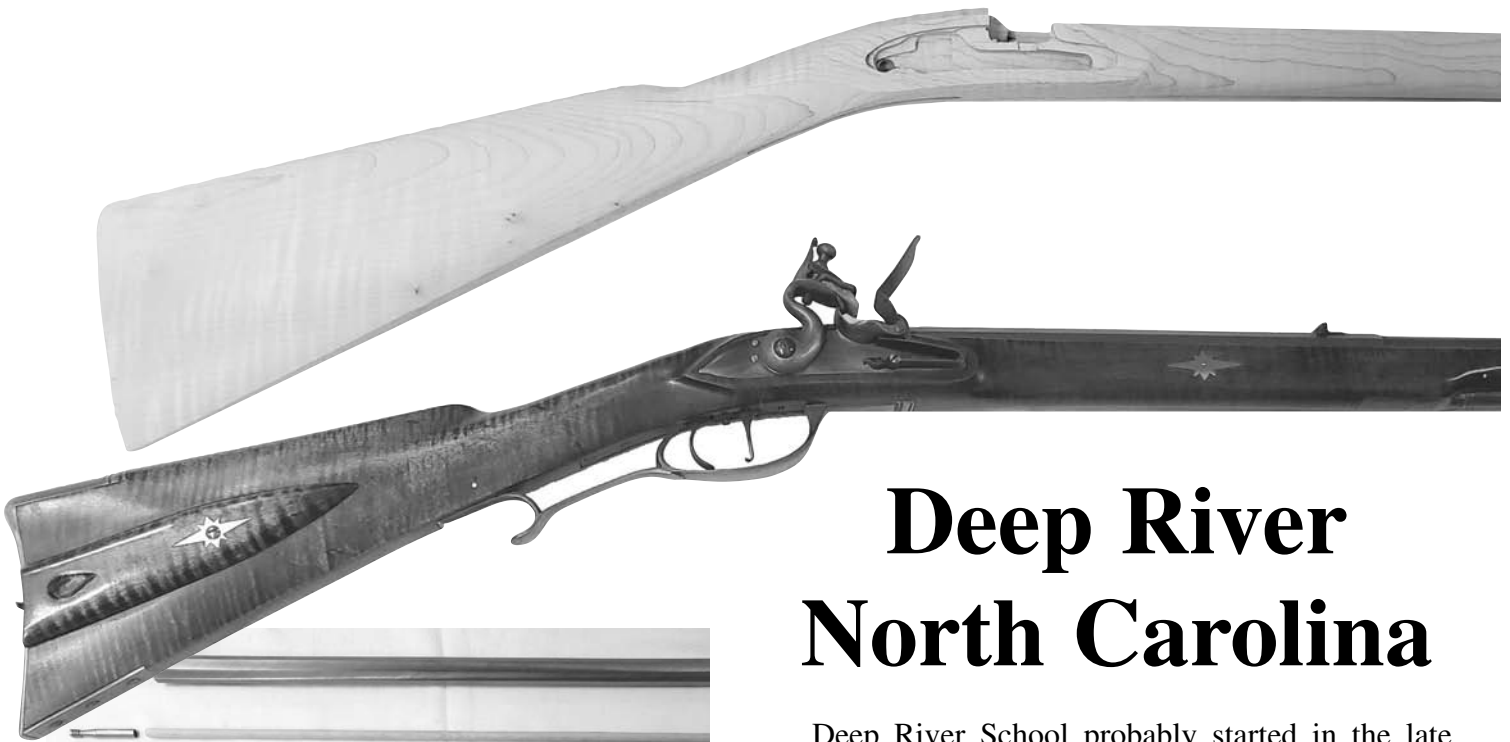

Deep River North Carolina

Deep River School probably started in the late 1760's and ended around 1810. During the Revolutionary war the local gunsmiths repaired General Nathanael Greene's Army weapons.

Around 1810 the early Deep River School evolved into the largest Long Rifle School in the Southern United States.



Grn. Mountain Barrel	3/4", 13/16" & 7/8" x 42"	\$225.00
Appropriate Lock	L&R DursE Flint	\$215.00
*Optional Lock	*(L&R perc.)	(\$150.00)
Appropriate dbl. - set Trigger	Davis #4	\$65.00
Appropriate Breech Plug	Fantail	\$12.00
Recommended Buttplate	Iron	\$29.00
Recommended Triggerguard	Iron	\$33.00
Recommended Thimbles	Steel (3)	\$22.00
Recommended Nose Cap	Steel	\$12.00
Lock Screws	(2)	\$3.50
Tang Screws	(1)	\$1.75
Rear Sight		\$10.00
Front Sight		\$8.00
Barrel Lugs	(3)	\$9.00
Barrel Keys (or Pins)	(3) Pins	N/C
Toe Plate	Steel	\$4.00
Sideplate	Steel	\$13.00
Touch Hole Liner		\$3.00
Drum & Nipple		*((\$8.00)
Ramrod Jag & Tip	Brass	\$4.50
Ramrod		\$4.75
*Optional Patchbox		*((\$22.00)
Misc. Screws		\$1.50
Stock Inletting & Drilling		\$57.50
Full Stock Prices: (Maple Grade)	Parts Total:	\$733.75 (Flint)
Curly Maple #1 \$170.00	Stock Price:	(_____)
Curly Maple #2 \$190.00	Grand Total:	(_____)
Curly Maple #3 \$250.00		
Curly Maple #4 \$325.00		
Curly Maple #5 \$450.00		
Cherry or Walnut \$235.00		



Specifications:

Lock Trigger & Tang Inletting Available

Overall length	59"
Barrel inlet	3/4", 1-3/16" and 7/8"
Ramrod hole drilled	3/8"
Butt width	1-3/4" x 5"
Lock area	1-1/2" x 7"
Drop at heel	4"
Trigger pull up to	14-1/4"

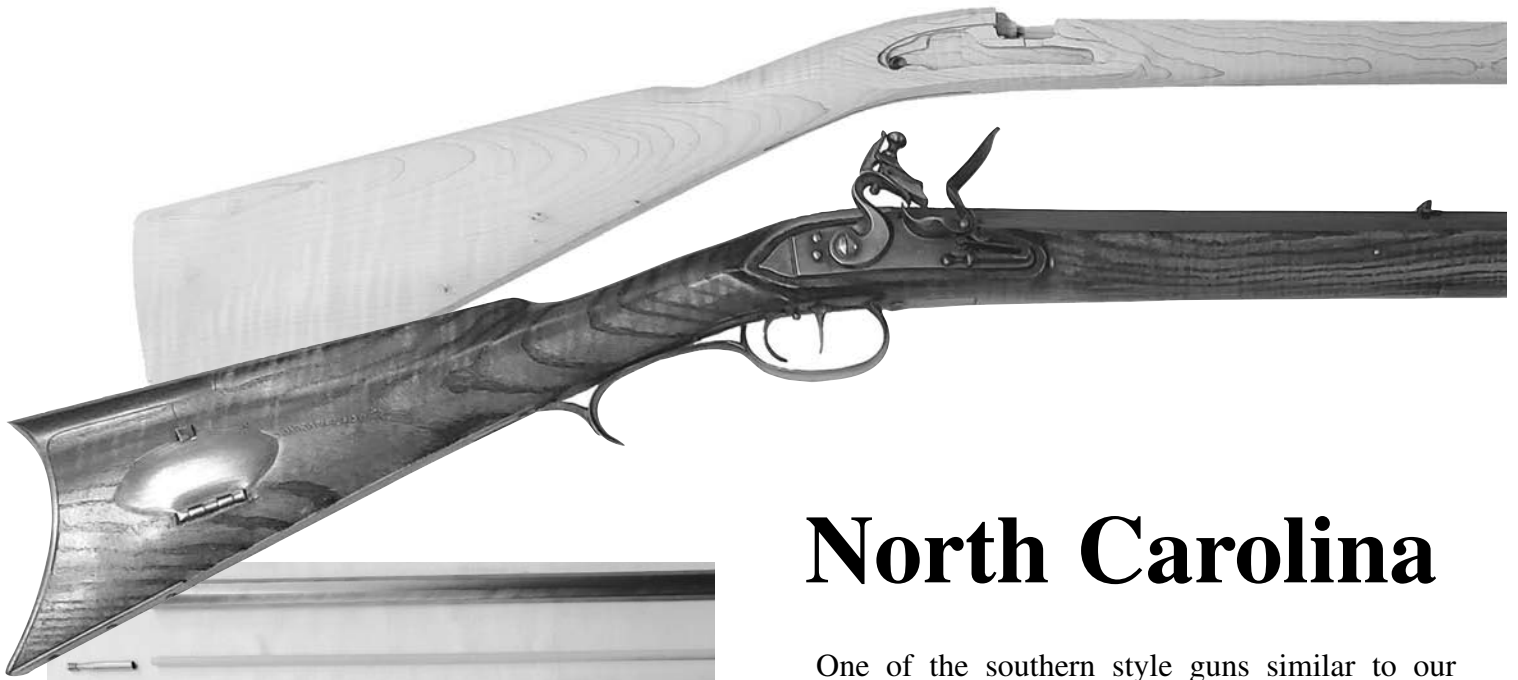

North Carolina

One of the southern style guns similar to our Tennessee, Southern Mountain and Tennessee Classic. Most were quite plain with little carving and most often used iron hardware. This stock is representative of the early 1800's rifle and is very comfortable to shoot. Comes inletted for a silver or L&R Durs Egg lock and Davis double set trigger as well as a flared tang.



Specifications:

Lock Trigger & Tang Inletting Available

Overall length	59"
Barrel inlet	3/4", 1-3/16" and 7/8"
Ramrod hole drilled	3/8"
Butt width	1-3/4" x 5"
Lock area	1-1/2" x 7"
Drop at heel	4"
Trigger pull up to	14-1/4"

Grn. Mountain Barrel	13/16" & 7/8" x 42"	\$225.00
Appropriate Lock	L&R DursE Flint	\$215.00
*Optional Lock	*(L&R perc.	\$150.00)
Appropriate dbl. - set Trigger	Davis #4	\$65.00
Appropriate Breech Plug	Fantail	\$12.00
Recommended Buttplate	Iron	\$29.00
Recommended Triggerguard	Iron	\$30.00
Recommended Thimbles	Steel (3)	\$22.00
Recommended Nose Cap	Steel	\$12.00
Lock Screws	(2)	\$3.50
Tang Screws	(1)	\$1.75
Rear Sight		\$10.00
Front Sight		\$8.00
Barrel Lugs	(3)	\$9.00
Barrel Keys (or Pins)	(3) Pins	N/C
Toe Plate	Steel	\$4.00
Sideplate	Steel	\$9.00
Touch Hole Liner		\$3.00
*Drum & Nipple		*(8.00)
Ramrod Jag & Tip	Brass	\$4.75
Ramrod		\$4.50
*Optional Patchbox		*(22.00)
Misc. Screws		\$1.50
Stock Inletting & Drilling		\$57.50

Full Stock Prices: (Maple Grade)

Curly Maple #1	\$170.00
Curly Maple #2	\$190.00
Curly Maple #3	\$250.00
Curly Maple #4	\$325.00
Curly Maple #5	\$450.00
Cherry or Walnut	\$235.00

Parts Total:	\$726.50 (Flint)
Stock Price: (_____)	
Grand Total:	_____

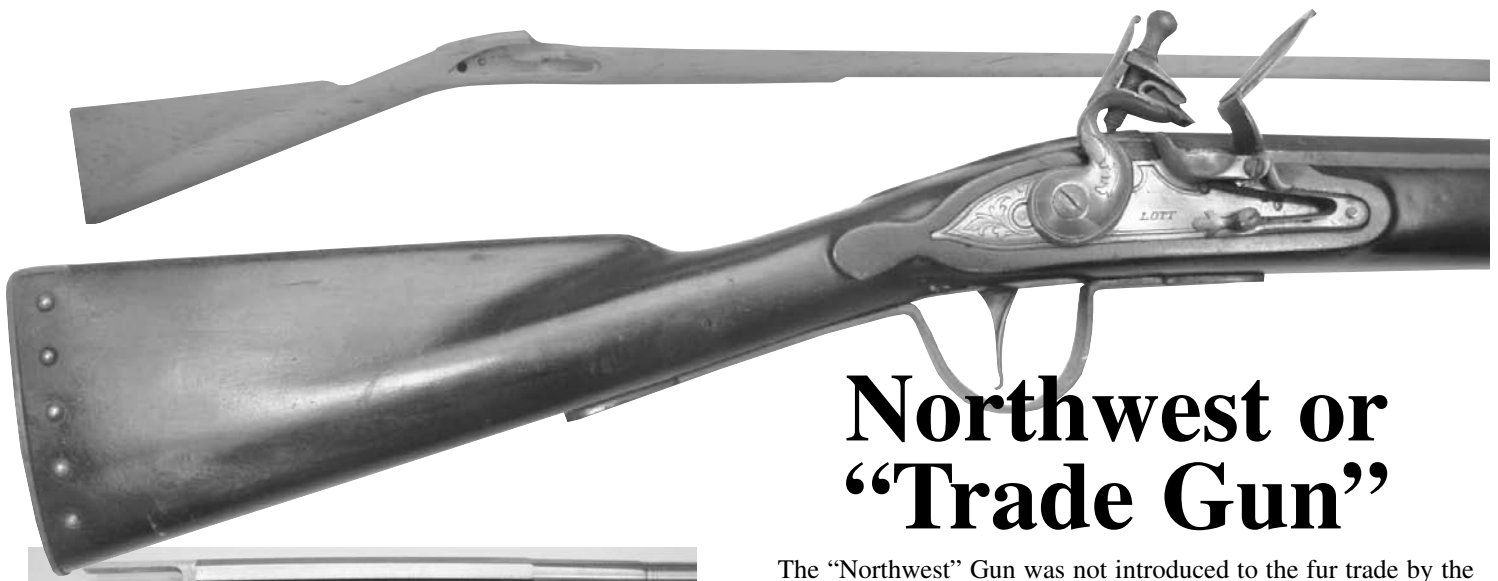

Northwest or “Trade Gun”

The “Northwest” Gun was not introduced to the fur trade by the North West Company. Instead, the gun was an early trade item that moved “northwest” of population and trading centers along the eastern coast of the United States and Canada.

The trade gun was typically light, often small and easy to handle. Barrel lengths varied between about 30” and 48”. The gun could fire shot (about 20 gauge) or a patched ball of about .62 calibre.

The trademark of this type gun is the cast brass dragon or sea serpent used as a side screwplate. Ramrod guides were also of ribbed brass and Indians and traders often ornamented the stock with brass tacks. The stock had a wide butt and drooped slightly forward. The forestock and wrist were slender and the barrel was thin.

The Triggerguard was large and made of iron. At first iron buttplates were nailed to the stock with small square nails. Later models used brass buttplates and screws.

Guns built for the trade after the middle of the 1800’s had a noticeably thicker wrist and heavier forestock. The butt took on a more military appearance but the old style butt stock with its grooves survived into the percussion period.

Another common feature of these guns was a sitting fox stamped on the lock. The fox faced right or left depending on the maker (the mark was copied) and the times. The fox convinced some Indians of the gun’s good quality.

The size of the gun, its versatility and its light weight made it a favorite Indian firearm for hunting and war. The gun proved so durable that it was used without any great changes in design, for more than 200 years and was still in use among some Northern tribes well into this century.



Specifications:

Lock Trigger & Tang Inletting Available

Overall length	55”
Pull length	15-1/2”
Drop at heel	2-5/8”
Barrel channel length	36” - 41”
Barrel channel size	3/4” round or 1” oct. to round
Ramrod hole size	3/8”
Lock mortice area	6-1/2” x 1-9/16”
Width at lock	1-3/4”
Butt	4-1/2” x 1-5/8”



Barrel	20 ga. 1” Octagon to Round	\$275.00
Appropriate Lock	L&R Trade Gun	\$215.00
Appropriate Trigger		\$30.00
Appropriate Breech Plug	With Barrel	-
Recommended Buttplate	Brass	\$29.00
Recommended Triggerguard	Steel	\$24.00
Recommended Thimbles	(2)	\$8.00
Recommended Nose Cap	(none)	-
Lock Screws	(2)	\$3.50
Tang Screws	(1)	\$1.75
Rear Sight	(none)	-
Front Sight		\$12.00
Barrel Lugs	(3)	\$9.00
Barrel Keys (or Pins)	(3) Pins	N/C
Escutcheons	(none)	-
Toe Plate	(none)	-
Sideplate	-	\$24.00
Touch Hole Liner		\$3.00
Ramrod Jag & Tip	-	\$4.75
Ramrod		\$4.50
Misc. Screws		\$1.50
Stock Inletting & Drilling		\$82.50

Full Stock Prices: (Maple Grade)

- Curly Maple #1 \$170.00
- Curly Maple #2 \$190.00
- Curly Maple #3 \$250.00
- Curly Maple #4 \$325.00
- Curly Maple #5 \$450.00
- Cherry or Walnut \$235.00

Parts Total:	\$727.50
Stock Price: (_____)	
Grand Total: _____	



Ohio Rifle

The "Ohio Rifle" covered a lot of territory. Some of these style rifles were actually built by gunsmiths working in Ohio, but many others were built by rifle-makers who settled throughout the Ohio Valley and along the Ohio River. The style, like the gunsmiths themselves, followed an expanding population along other rivers coming into Illinois and other areas east of the Mississippi.

These rifles were a product of their time and place. Unlike the "Plains Rifle" which served the early trappers and traders, or the "Hawkins" being used by the traders and trappers in the shining mountains, the Ohio Rifle was a gun for a gentleman and was popular for hunting small game and competing in friendly shooting matches.

The end of the Blackhawk Indian War in the 1830's made settlers throughout the Midwest area feel more secure from the threat of Indian attack. The Indians were moved west and south, large game was gone or greatly reduced in numbers near the settlements and there was no need for the .50 calibre or larger rifle and its demand for greater quantities of powder and lead.

The Ohio Rifle was good for squirrels and similar small game. It was a smaller calibre rifle, with a half-stock (often of walnut). The fish-belly stock was a popular design and because it was in the hands of men who had (at least to some extent) prospered, it included brass and silver inlays and sometimes wire inlay designs. There were undoubtedly many plainer versions of this rifle that found their way into the homes of farmers and the camps of herdsman and hunters.

Like the original "Ohio" style rifles, we know that some gentlemen (and ladies) will want some custom modifications and we can offer these rifles either without a cheek piece or with the cheek piece on both sides.

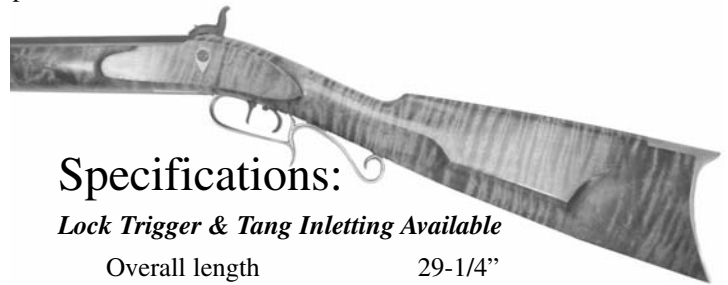

Specifications:

Lock Trigger & Tang Inletting Available

Overall length	29-1/4"
Pull length	15"
Drop at heel	3-3/4"
Barrel channel length	13"
Barrel channel size	13/16" and 7/8"
Ramrod hole size	3/8"
Lock mortice area	1-15/16" x 5-3/4"
Width at lock	1-1/2"
Butt	1-3/8" x 4-5/16"



Grn. Mountain Barrel	13/16" & 7/8" x 36"	\$225.00
Appropriate Lock	L&R Warranted perc.	\$150.00
Appropriate dbl. - set Trigger	Davis #4	\$65.00
Appropriate Breech Plug		\$12.00
Recommended Buttplate	Brass	\$36.00
Recommended Triggerguard	Brass	\$36.00
Recommended Thimbles	(2) Oct. Brass	\$16.00
Recommended Nose Cap	(none, should be poured)	
Lock Screws	(1)	\$1.75
Tang Screws	(1)	\$1.75
Barrel Rib		\$36.00
Rear Sight		\$10.00
Front Sight		\$8.00
Barrel Lugs	(1)	\$3.00
Barrel Keys (or Pins)	(1) Pins	N/C
Escutcheons	(none)	-
Toe Plate	(none)	-
Sideplate		\$9.00
Drum & Nipple		\$8.00
Ramrod Jag & Tip		\$4.75
Ramrod		\$4.50
Misc. Screws		\$1.50
Stock Inletting & Drilling		\$57.50

Half Stock Prices: (Maple Grade)

Curly Maple #1	\$105.00
Curly Maple #2	\$120.00
Curly Maple #3	\$175.00
Curly Maple #4	\$215.00
Curly Maple #5	\$280.00
Cherry or Walnut	\$160.00

Parts Total:	\$685.75
Stock Price: (_____)	
Grand Total: _____	



Schuetzen Halfstock

The percussion Schuetzen was popular during the 1870's and 1880's before the metallic cartridge was perfected.

Designed for offhand shooting, these heavy stocked rifles featured large cheek pieces. Double set triggers hook schuetzen buttplates, fancy scroll shape trigger guards, and palm rests. Barrels were heavy, rifled for a conical bullet of .32 to .38 caliber. They were shot offhand at 100 to 200 yards. Weight of the rifle was approximately ten to eleven pounds.

Our Schuetzen rifle features a 1 inch Green Mountain barrel in .32, .38, .40, and .45 caliber with a fast twist for conical bullets. Round ball barrels are used for competitive shooting up to 100 yards.

As these are target guns, no ramrod, ramrod pipes, or barrel rib are included. Loading and cleaning rods are used at the bench. Sights are also not included as peep or vernier sights are used on the rear and aperture front sights are generally used.



Specifications:

Lock Trigger & Tang Inletting Available

Overall length	27-1/2"
Pull length	14-1/2"
Drop at heel	4"
Barrel channel length	12"
Barrel channel size	15/16" and 1"
Ramrod hole size	3/8" optional
Lock mortice area	1-7/8" x 7"
Width at lock	1-3/4"
Butt	1-3/4" x 5"



Grn. Mountain Barrel	1" x 36"	\$225.00
Appropriate Lock	L&R Perc.	\$150.00
Appropriate dbl. - set Trigger	L&R	\$85.00
Appropriate Breech Plug	L&R	\$90.00
Recommended Buttplate	Brass	\$40.00
Recommended Triggerguard	Brass	\$38.00
Recommended Thimbles	(none)	-
Recommended Nose Cap	(none)	-
Lock Screws	(1)	\$1.75
Tang Screws	(1)	\$1.75
Barrel Rib	(none)	-
Rear Sight	(none)	-
Front Sight	(none)	-
Barrel Lugs	(1)	\$6.00
Barrel Keys (or Pins)	(1)	\$6.00
Escutcheons	(2)	\$4.00
Toe Plate	(none)	-
Sideplate	(1)	\$8.00
Touch Hole Liner	(none)	-
Nipple	Nipple	\$3.00
Ramrod Jag & Tip	(none)	-
Ramrod	(none)	-
Misc. Screws		\$1.50
Stock Inletting & Drilling		\$57.50

Half Stock Prices: (Maple Grade)

Curly Maple #1	\$105.00
Curly Maple #2	\$120.00
Curly Maple #3	\$175.00
Curly Maple #4	\$215.00
Curly Maple #5	\$280.00
Cherry or Walnut	\$160.00

Parts Total:	\$607.50
Stock Price: (_____)	
Grand Total:	_____



Schweitzer

Abraham Schweitzer of the Chambersburg School learned the gunsmithing trade in Lancaster, Pa., in the late 1780's, established as a gunsmith in Chambersburg, Franklin County, Pa. in 1805.

In the late flintlock period that is the 1820's and 1830's, Chambersburg rifles took on the appearance of our stock shown here.

The butt stock of Schweitzer rifles exhibited profiles that have straight lower lines and straight combs. The front end of the comb does not lie far above the line of the wrist.

Abraham Schweitzer was a first rate designer and carver of rifle stocks.



Grn. Mountain Barrel	13/16" & 7/8" x 42"	\$225.00
Appropriate Lock	L&R Classic Flint	\$215.00
*Optional Lock	*(L&R Classic Perc.)	(\$150.00)
Appropriate dbl. - set Trigger	Davis #4	\$65.00
Appropriate Breech Plug	Fantail	\$12.00
Recommended Buttplate	Brass	\$22.00
Recommended Triggerguard	Brass	\$22.00
Recommended Thimbles	Brass (3)	\$24.00
Recommended Nose Cap	Brass	\$12.00
Lock Screws	(2)	\$3.50
Tang Screws	(1)	\$1.75
Barrel Rib	(none)	-
Rear Sight		\$10.00
Front Sight		\$8.00
Barrel Lugs	(3)	\$9.00
Barrel Keys (or Pins)	(3) Pins	N/C
Escutcheons	Brass (6)	\$6.00
Toe Plate	Brass	\$6.00
Sideplate	Brass	\$9.00
Touch Hole Liner		\$3.00
Drum & Nipple		*(8.00)
Ramrod Jag & Tip	Brass	\$4.75
Ramrod		\$4.50
*Optional Patchbox		*(40.00)
Misc. Screws		\$1.50
Stock Inletting & Drilling		\$57.50

Full Stock Prices: (Maple Grade)

- Curly Maple #1 \$170.00
- Curly Maple #2 \$190.00
- Curly Maple #3 \$250.00
- Curly Maple #4 \$325.00
- Curly Maple #5 \$450.00
- Cherry or Walnut \$235.00

Parts Total:	\$721.50 (Flint)
Stock Price:	(_____)
Grand Total:	_____



Specifications:

Lock Trigger & Tang Inletting Available

Overall length	59"
Pull length	15-1/2"
Drop at heel	3-3/4"
Barrel channel length	42"
Barrel channel size	7/8" and 13/16"
Ramrod hole size	3/8"
Lock mortice area	1-1/2" x 7"
Width at lock	1-1/2"
Butt	1-5/8" x 5"

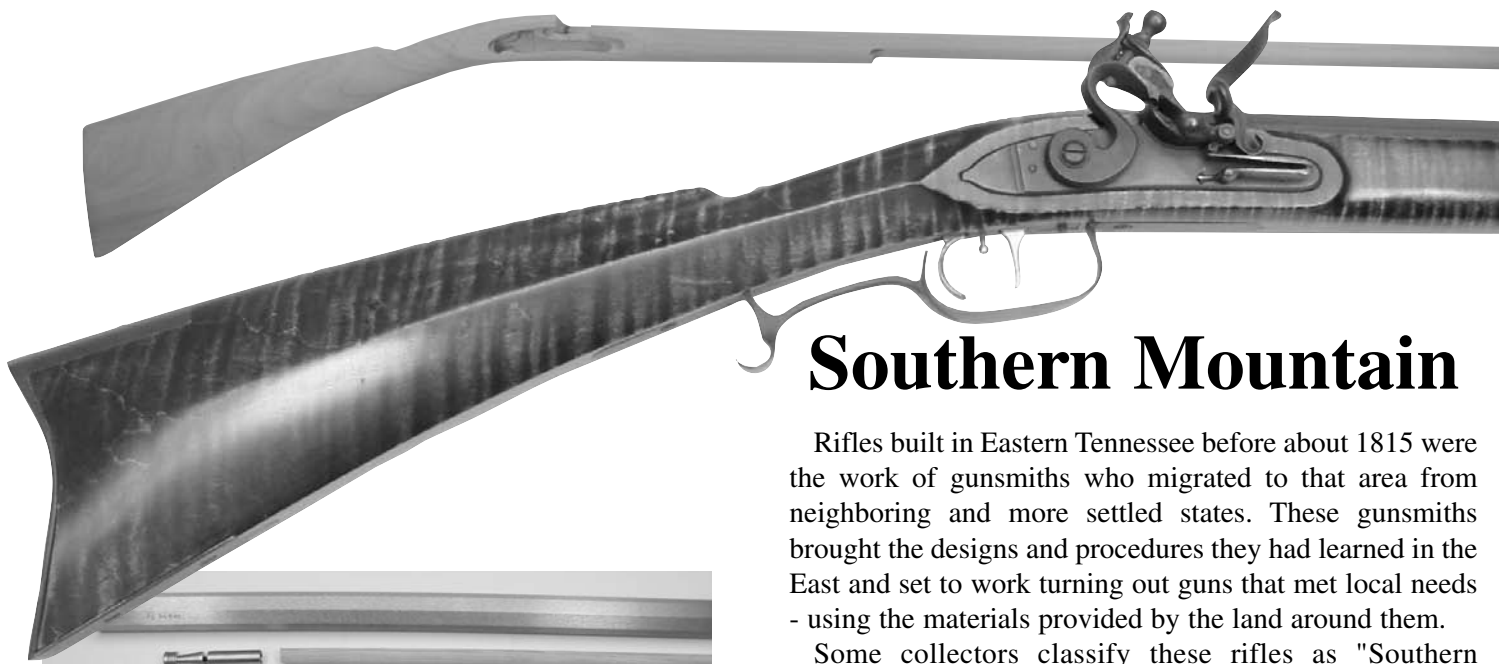

Southern Mountain

Rifles built in Eastern Tennessee before about 1815 were the work of gunsmiths who migrated to that area from neighboring and more settled states. These gunsmiths brought the designs and procedures they had learned in the East and set to work turning out guns that met local needs - using the materials provided by the land around them.

Some collectors classify these rifles as "Southern Kentuckies" although Tennessee was a part of North Carolina until it became a state in 1796.

One important difference between the "Kentucky" and the "Tennessee" was the use of iron for fittings, instead of brass. (Iron was abundant in the region and the metals needed for brass were not successfully mined until the turn of the 19th Century.) Silver and pewter were often used for mountings in these rifles. The silver usually came from coins circulated during this period.

Walnut and maple were the favorite woods for stocks, but other woods including cherry and ash were sometimes used.

These early guns often utilized the more simple "banana style" Patchbox, long barrels, wide buttplates and wide trigger guards. A very few may have included relief carving. Long tangs were common.

The general lines of these rifles are not unlike their Kentucky cousins, although the rifle is usually less ornamented and is not carved. It has a rugged simplicity and attractiveness.

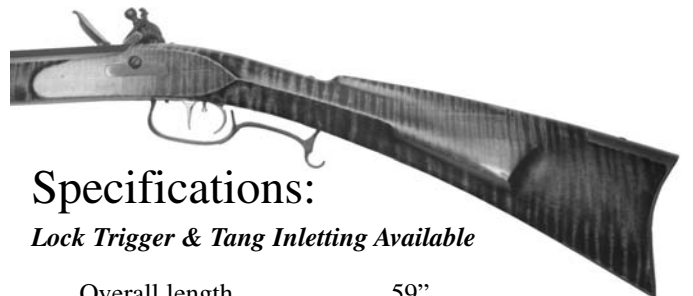

Specifications:

Lock Trigger & Tang Inletting Available

Overall length	59"
Pull length	15"
Drop at heel	4-1/4"
Barrel channel length	42"
Barrel channel size	13/16" or 7/8"
Ramrod hole size	3/8"
Lock mortice area	1-7/16" x 6-7/8"
Width at lock	1-3/4"
Butt	1-5/8" x 5-1/4"



Grn. Mountain Barrel	13/16" & 7/8" x 42"	\$225.00
Appropriate Lock	L&R DursE Flint	\$215.00
*Optional Lock	*(L&R perc.)	(\$150.00)
Appropriate dbl. - set Trigger	Davis #4	\$65.00
Appropriate Breech Plug	Lollypop Tang	\$24.00
Recommended Buttplate	Iron	\$29.00
Recommended Triggerguard	Iron	\$33.00
Recommended Thimbles	Steel (3)	\$18.00
Recommended Nose Cap	Steel	\$12.00
Lock Screws	(2)	\$3.50
Tang Screws	(2)	\$3.50
Rear Sight		\$10.00
Front Sight		\$8.00
Barrel Lugs	(3)	\$9.00
Barrel Keys (or Pins)	(3) Pins	N/C
Escutcheons	(none)	-
Toe Plate	Steel	\$4.00
Sideplate	Steel	\$5.00
Touch Hole Liner		\$3.00
Drum & Nipple		*(8.00)
Ramrod Jag & Tip	Brass	\$4.75
Ramrod		\$4.50
*Optional Patchbox		*(30.00)
Misc. Screws		\$1.50
Stock Inletting & Drilling		\$57.50

Full Stock Prices: (Maple Grade)

- Curly Maple #1 \$170.00
- Curly Maple #2 \$190.00
- Curly Maple #3 \$250.00
- Curly Maple #4 \$325.00
- Curly Maple #5 \$450.00
- Cherry or Walnut \$235.00

Parts Total:	\$735.25 (Flint)
Stock Price: (_____)	
Grand Total: _____	

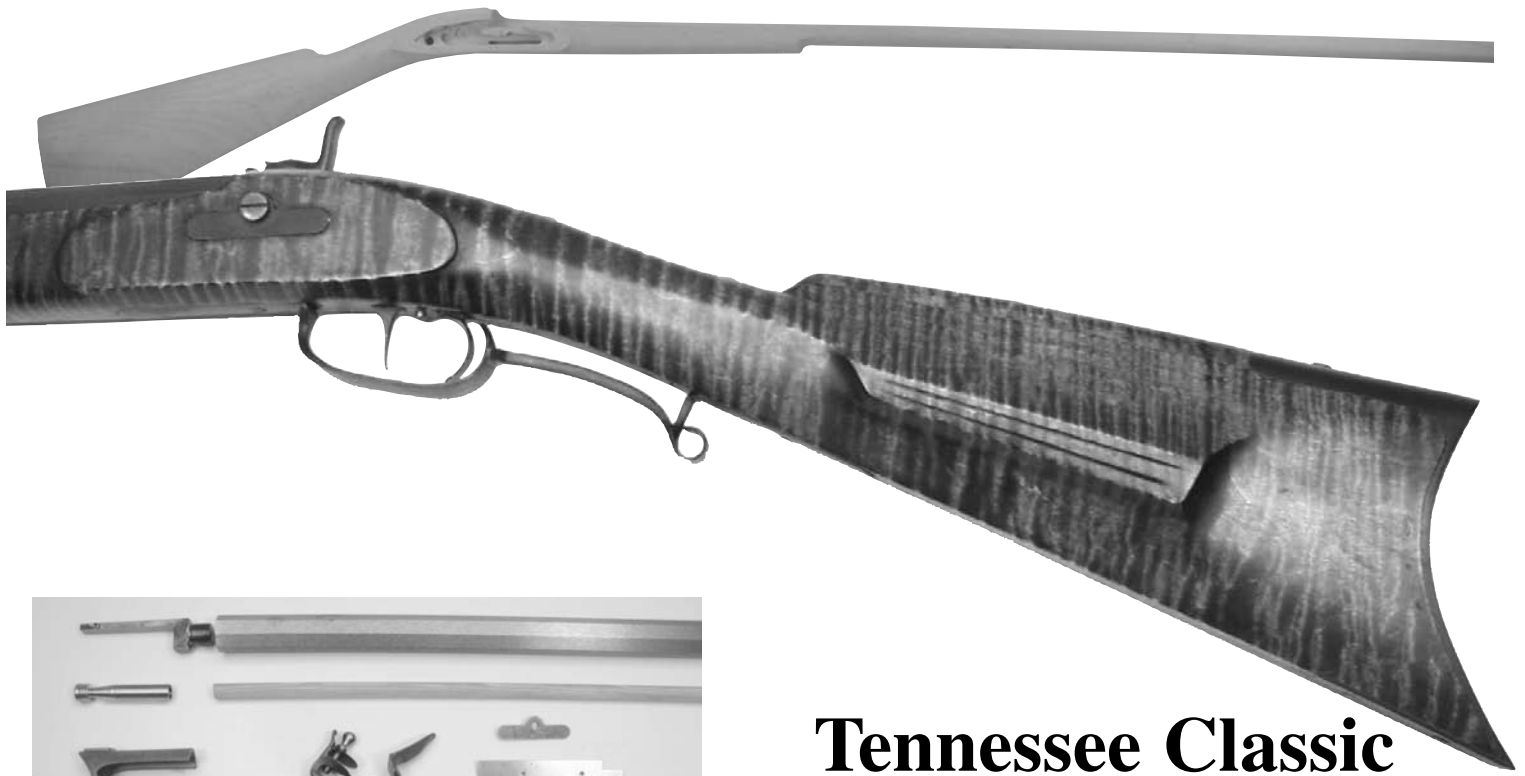

Tennessee Classic

Our Tennessee Classic fullstock is a long rifle inspired by the creativeness of the mountain folks from the mountain regions of North Carolina and Tennessee. Functional guns without fancy inlays or carving. Iron was the predominant metal used as brass was in short supply in the hills of Tennessee. Most parts were hand forged with the exception of the locks which were generally imported.

A very comfortable gun to shoot with more drop than the Tennessee Mountain, but less than the Southern Mountain. The buttstock has a straight comb and well defined cheek piece.

Maple and walnut were the most frequently used woods but cherry and ash were also seen.



Specifications:

Lock Trigger & Tang Inletting Available

Overall length	59"
Pull length	15"
Drop at heel	4"
Barrel channel length	42"
Barrel channel size	13/16" or 7/8"
Ramrod hole size	3/8"
Lock mortice area	1-1/2" x 6-3/4"
Width at lock	1-1/2"
Butt	1-1/2" x 4-3/4"



Grn. Mountain Barrel	13/16" & 7/8" x 42"	\$225.00
Appropriate Lock	L&R Classic Flint	\$215.00
*Optional Lock	*(L&R Classic Perc.)	(\$150.00)
Appropriate dbl. - set Trigger	Davis #4	\$65.00
Appropriate Breech Plug	Straight Tang	\$12.00
Recommended Buttplate	Iron	\$29.00
Recommended Triggerguard	Iron	\$28.00
Recommended Thimbles	Steel (3)	\$18.00
Recommended Nose Cap	Steel	\$12.00
Lock Screws	(2)	\$3.50
Tang Screws	(1)	\$1.75
Rear Sight		\$10.00
Front Sight		\$8.00
Barrel Lugs	(3)	\$9.00
Barrel Keys (or Pins)	(3) Pins	N/C
Toe Plate	Steel	\$4.00
Sideplate	Steel	\$5.00
Touch Hole Liner		\$3.00
Drum & Nipple		*((\$8.00)
Ramrod Jag & Tip	Brass	\$4.75
Ramrod		\$3.50
*Optional Patchbox		*((\$30.00)
Misc. Screws		\$1.50
Stock Inletting & Drilling		\$57.50

Full Stock Prices: (Maple Grade)

Curly Maple #1	\$170.00
Curly Maple #2	\$190.00
Curly Maple #3	\$250.00
Curly Maple #4	\$325.00
Curly Maple #5	\$450.00
Cherry or Walnut	\$235.00

Parts Total:	\$716.50
Stock Price: (_____)	
Grand Total: _____	



Tennessee Mountain

The Tennessee Mountain Rifle is truly one of the guns that won the West. These rifles were produced in the area of the Southern Mountains as settlements moved west and further away from the populated areas of the east.

The rifle-makers in these areas were generally far removed from their sources of supply and so many of the "extras" (such as the brass Patchbox) were eliminated and they produced rifles of classic simplicity, rugged and accurate.

These Mountain Rifles usually had iron fittings and some simply had a hole drilled in the butt stock for patching grease. We have seen these rifles with fittings made from horn and antler and they are an interesting contrast to their more splendid cousin – the Kentucky rifle.

Many of these rifles found their way into the hands of the people who settled in the mountains and were used to harvest the hogs that had been running wild. They still are called "hog rifles" in some parts of the Smoky Mountains today. Other rifles of this type went to trappers, traders and hunters and the simplicity of the lines, as well as the ruggedness of the rifle, made the Tennessee Mountain Rifle a favorite.

This gun will look particularly good if metal parts are browned and a dark stain is used for the stock. A wood or "banana style" iron Patchbox can be found on some of the early models. Cowhorn or antler will provide just a touch of authentic color and can be used for an inlay or two or shaped for the rifle's nosecap.



Specifications:

Lock Trigger & Tang Inletting Available

Overall length	59"
Pull length	15-1/2"
Drop at heel	3-1/2"
Barrel channel length	42"
Barrel channel size	13/16" or 7/8"
Ramrod hole size	3/8"
Lock mortice area	1-7/16" x 6"
Width at lock	1-9/16"
Butt	1-1/2" x 4-1/4"

Also available in left hand



Grn. Mountain Barrel	13/16" & 7/8" x 42"	\$225.00
Appropriate Lock	L&R Manton	\$215.00
*Optional Lock	*(Manton Perc.)	(\$150.00)
Appropriate dbl. - set Trigger	L&R	\$65.00
*Optional Trigger System	(Davis #4)	(\$65.00)
Appropriate Breech Plug	Lollypop Tang	\$24.00
Recommended Buttplate	Iron	\$32.00
Recommended Triggerguard	Iron	\$33.00
Recommended Thimbles	Steel (3)	\$18.00
Recommended Nose Cap	Steel	\$12.00
Lock Screws	(2)	\$3.50
Tang Screws	(2)	\$3.50
Rear Sight		\$10.00
Front Sight		\$8.00
Barrel Lugs	(3)	\$9.00
Barrel Keys (or Pins)	(3) Pins	N/C
Escutcheons	(none)	-
Toe Plate	Steel	\$4.00
Sideplate	Steel	\$5.00
Touch Hole Liner		\$3.00
Drum & Nipple		*(8.00)
Ramrod Jag & Tip	Brass	\$4.75
Ramrod		\$4.50
*Optional Patchbox		*(20.00)
Misc. Screws		\$1.50
Stock Inletting & Drilling		\$57.50

Full Stock Prices: (Maple Grade)

- Curly Maple #1 \$170.00
- Curly Maple #2 \$190.00
- Curly Maple #3 \$275.00
- Curly Maple #4 \$325.00
- Curly Maple #5 \$450.00
- Cherry or Walnut \$235.00

Parts Total:	\$738.25	(Flint)
Stock Price:	(_____)	
Grand Total:	_____	

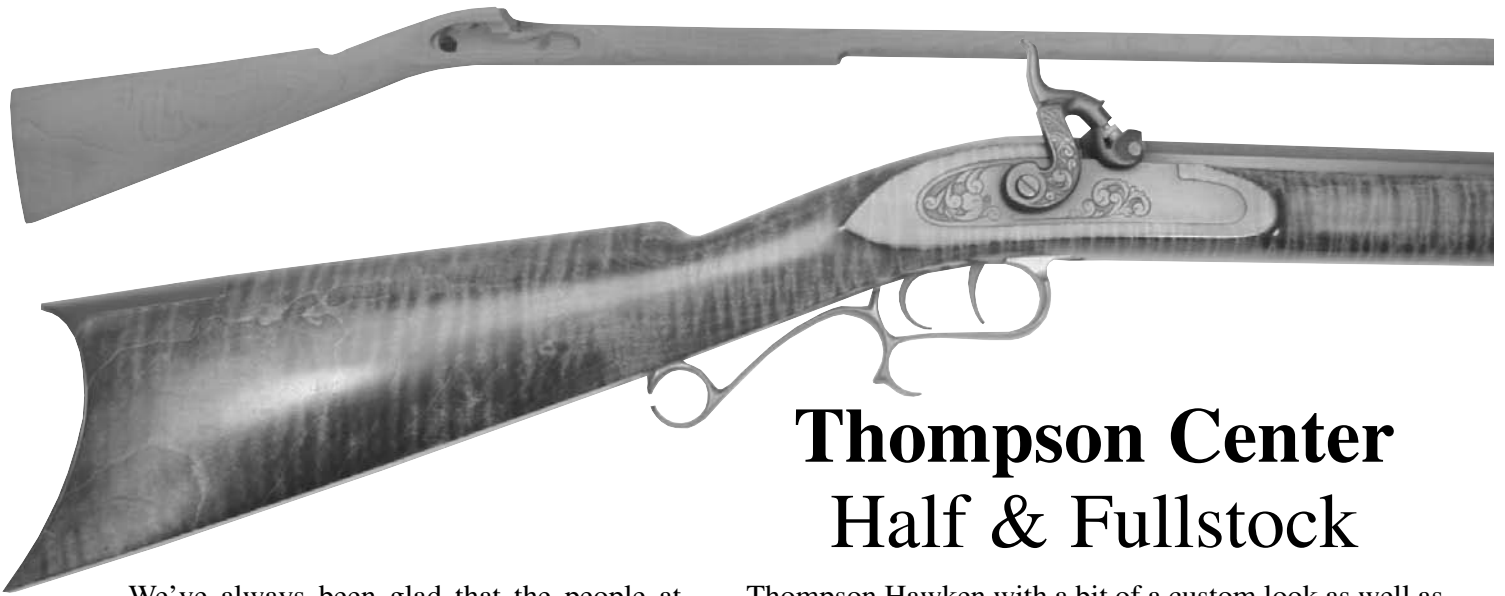

Thompson Center Half & Fullstock

We've always been glad that the people at Thompson Center waited until after we became interested in black powder shooting and building before coming out with the Thompson Hawken. It would have been just too easy for us to obtain a ready-made, affordable rifle. We might never have made those first guns that got us interested in making stocks as a business. And then, of course, we would not be manufacturing stocks today.

When we attend the various shoots and visit clubs, the tremendous impact that Thompson Center has made in the muzzle loading industry is evident. Every time you turn around you see one of the millions they have sold. Probably when you stop to think about it, there are a good many of us who wouldn't be as far as we are in the muzzle loading business except for the efforts of Thompson Center.

Without taking anything away from Thompson Center, we believe that our stocks enhance the

Thompson Hawken with a bit of a custom look as well as the shape and design of the even earlier Hawken's of Jake and Sam.

Nearly all the parts from your Thompson Center Hawken will fit neatly into place without too much fuss. The only thing we have left open for you is pull length. And that was intentional.

When we asked various owners of the Thompson Hawken what they would like to see on a custom stock, two statements were frequent. First, they would like to see more drop in the stock. Ours has "more than the factory equipped model." Second, pull length, shooters vary so greatly in that one statistic and it is one of the most vital factors in shooting comfortably. So Gentlemen, the choice of pull is now yours.

The Thompson replacement stock is available only for the Hawken and Renegade models, in all woods and only in what we call our 98% inlet form.

Thompson Center Halfstock

	Inletted Halfstock	Inletted Fullstock
Curly Maple #1	\$165.00	\$230.00
Curly Maple #2	\$180.00	\$250.00
Curly Maple #3	\$235.00	\$310.00
Curly Maple #4	\$275.00	\$385.00
Curly Maple #5	\$340.00	\$510.00
Cherry or Walnut	\$220.00	\$295.00

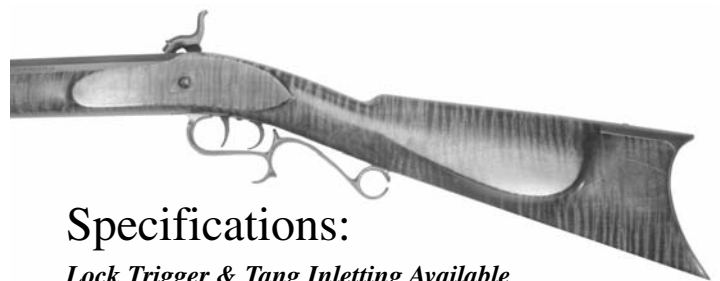

Specifications:

Lock Trigger & Tang Inletting Available

	Half Stock	Fullstock
Overall length	30-3/4"	54"
Pull Length	14-1/2"	14-1/2"
Drop at heel	3"	3"
Barrel channel length	14-1/2"	36"
Barrel channel size	15/16" & 1"	15/16" & 1"
Ramrod hole size	3/8"	3/8"
Lock mortice area	1-1/4" x 6-3/4"	1-1/4" 6-3/4"
Width at lock	1-5/8"	1-5/8"
Butt	4-1/2" x 1-1/2"	4-1/2" 1-1/2"



Transitional Kentucky

The First Truly American Firearm

In the 1700's a new rifle was developed in Pennsylvania to meet the needs of a nation which was truly perched on the frontier.

"Although it had its limitations in design and ornamentation, it was extremely accurate and very satisfactory for killing game at great distances."

Because the gunsmiths who settled in Pennsylvania were trained in central Europe the "Jaeger" influence is very apparent in the early frontier rifles.

The "new rifle" had a maple wood fullstock, a long octagonal barrel (40" or longer), a smaller bore (50 calibre or smaller, the Jaeger is traditionally 60 to 75 calibre), and in the buttstock a cavity covered by a hinged brass plate.

This gun evolved into the long, slender "Golden Age Pennsylvania Rifle" we all know and love.

Here at Pecatonica we feel that this fine rifle has not received the attention from modern gun builders that it deserves. Therefore we have brought out our Transitional Kentucky stock in 98% inletted form for those who wish to reproduce this fine historic piece. We have selected components for this rifle which reflect the period.



Specifications:

Lock Trigger & Tang Inletting Available

Overall length	54-3/4"
Pull length	15"
Drop at heel	2-3/4"
Barrel channel length	39"
Barrel channel size	15/16"*
Ramrod hole size	3/8"
Lock mortice area	1-1/2" x 7-1/4"
Butt	1-15/16" x 5"

**Available with Colerain swamped barrel \$205.00. Additional \$65.00 inletting for swamped barrel. (Deduct price of original barrel).



Grn. Mountain Barrel	15/16" & 36"	\$225.00
Appropriate Lock	Davis Jaeger	\$210.00
Appropriate dbl. - set Trigger	Davis #4	\$65.00
Appropriate Breech Plug	Fantail	\$12.00
Recommended Buttplate	Brass	\$36.00
Recommended Triggerguard	Brass	\$36.00
Recommended Thimbles	Brass	\$40.00
Recommended Nose Cap	Brass	\$12.00
Lock Screws	(2)	\$3.50
Tang Screws	(1)	\$1.75
Rear Sight		\$12.00
Front Sight		\$9.00
Barrel Lugs	(3)	\$9.00
Barrel Keys (or Pins)	(3) Pins	N/C
Escutcheons	(none)	-
Toe Plate	(none)	-
Sideplate		\$23.00
Touch Hole Liner		\$3.00
Drum & Nipple	(none)	-
Ramrod Jag & Tip	Brass	\$4.75
Ramrod		\$4.50
*Optional Patchbox	(none)	-
Misc. Screws		\$1.50
Stock Inletting & Drilling		\$57.50

Full Stock Prices: (Maple Grade)

Curly Maple #1	\$170.00
Curly Maple #2	\$190.00
Curly Maple #3	\$250.00
Curly Maple #4	\$325.00
Curly Maple #5	\$450.00
Cherry or Walnut	\$235.00

Parts Total:	\$765.00
Stock Price: (_____)	
Grand Total: _____	

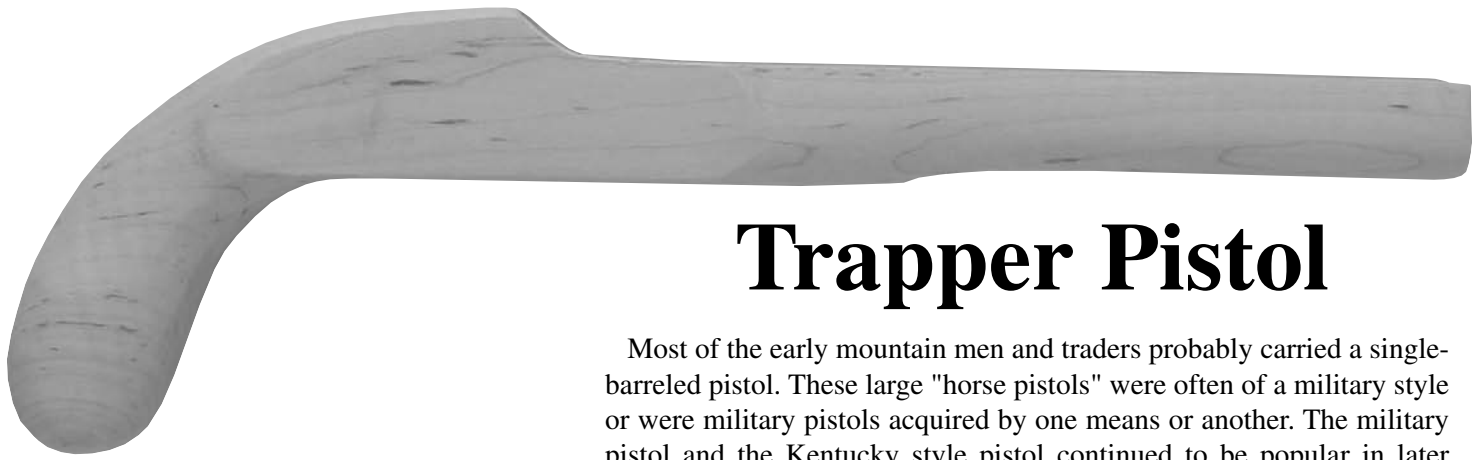

Trapper Pistol

Most of the early mountain men and traders probably carried a single-barreled pistol. These large "horse pistols" were often of a military style or were military pistols acquired by one means or another. The military pistol and the Kentucky style pistol continued to be popular in later years.

These two styles had proven themselves reliable, and that was a great importance to a trapper who might have to stake his life on a pistol's ability to provide a back-up shot in what could be a desperate situation.

Carrying a pistol was more practical than carrying two rifles, and most trappers probably would have preferred to avoid carrying unnecessary equipment over mountains and across rivers.

These factors, combined with an appreciation for the stopping power of large-bore weapons, would combine to encourage the development of a large-bore pistol of military size and Kentucky lines. By ordering a pistol in the same calibre as his rifle, the trapper eliminated the need for an extra bullet mold and the constant carrying of two different sizes of lead balls. That doesn't mean that all mountain men and trappers carried this style of pistol.

Specifications:

Lock Trigger & Tang Inletting Available

Overall length	16"
Barrel channel length	10-1/2"
Barrel channel sizes	15/16" & 1"
Lock mortice area	1-5/8" x 5-3/4"
Width at lock	1-3/4"
Ramrod hole size	3/8"

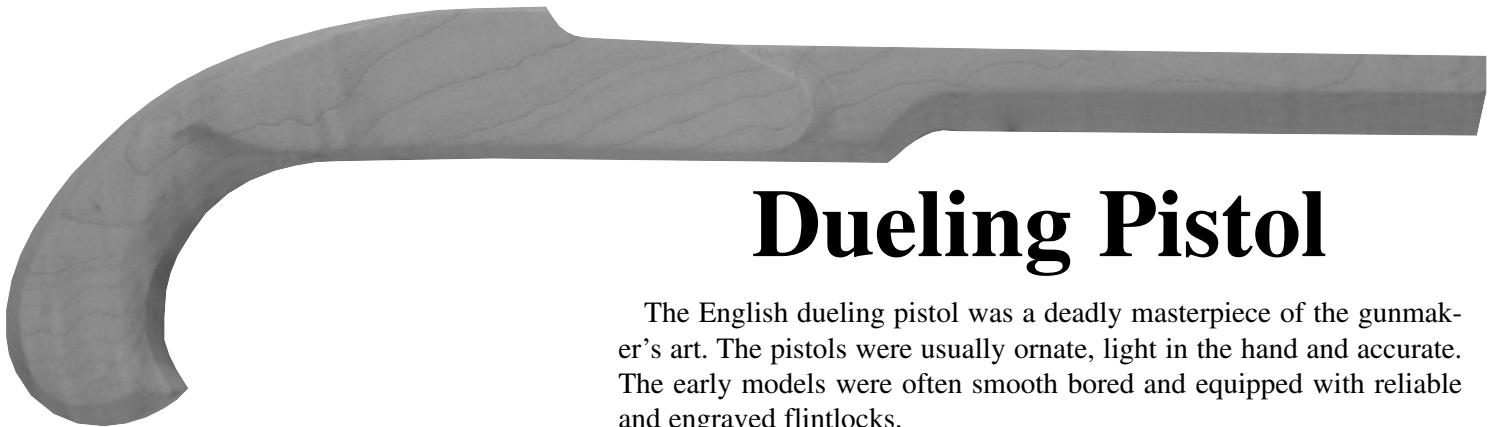

Dueling Pistol

The English dueling pistol was a deadly masterpiece of the gunmaker's art. The pistols were usually ornate, light in the hand and accurate. The early models were often smooth bored and equipped with reliable and engraved flintlocks.

The pistols were not always used for the purpose of dueling, but possession of a set was the mark of a gentleman of means. That's because dueling wasn't a sport, nor was it permitted among the common folk. The history of dueling can probably be linked to the "trial by combat" of knights in medieval times. There were rigid rules, and the "code duello" governed behavior of the combatants and their seconds. Few duels were fought "to the death" and the drawing of blood was sufficient to soothe the honor of most participants.

Dueling became unfashionable and illegal, but these style pistols are a reminder of a time when a man's honor was a matter of life and death – a time when a sunrise, and a beautifully engraved carefully stocked and balanced pistol might have been the last sight of many a good and bad man.

Specifications:

Lock Trigger & Tang Inletting Available

Overall length	15-1/4"
Barrel channel length	9-1/2"
Barrel channel size	13/16" and 7/8"
Lock mortice area	1-1/4" x 5-3/4"
Width at lock	1-1/2"
Ramrod hole size	15/16"

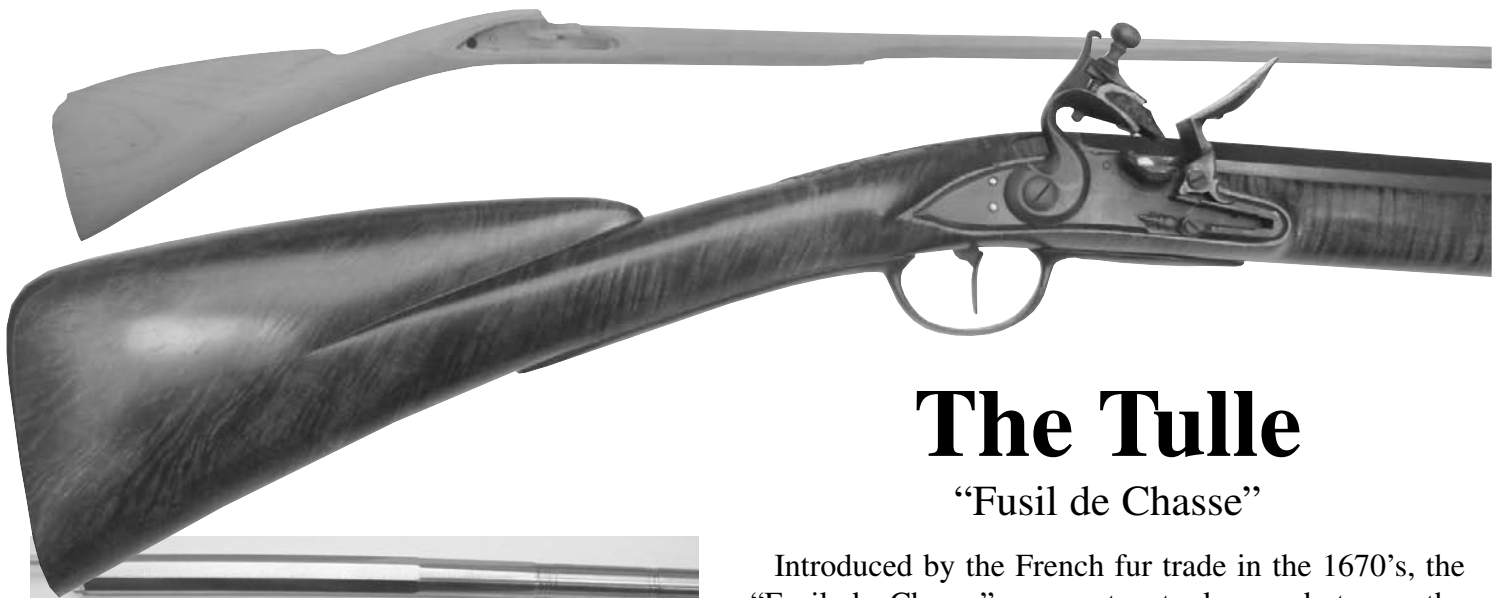

The Tulle

“Fusil de Chasse”

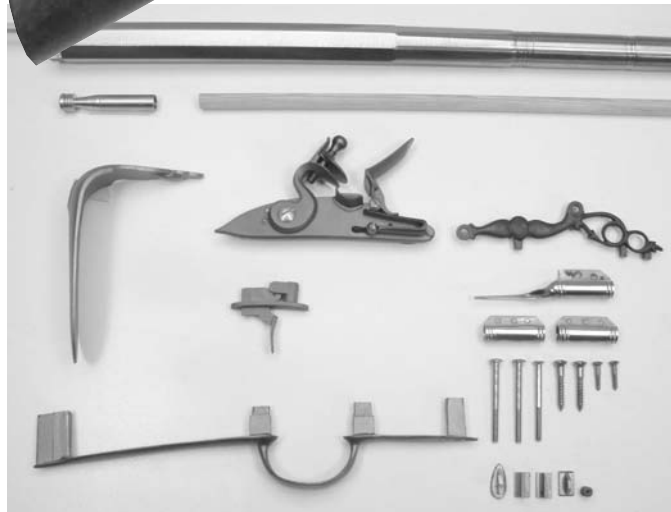

Introduced by the French fur trade in the 1670's, the “Fusil de Chasse” was not a trade gun but was the weapon of the Voyageur, the French fur traders and eventually Rodgers Rangers.

The Tulle “Fusil de Chasse” or hunting gun was lighter, with cleaner lines, than the military or trade guns of the era. Imported in large numbers, it saw use in Canada and the Mississippi River valley.

We at Pecatonica Long Rifle Supply feel we have faithfully recreated the “Tulle” gun using modern materials.

Of the Indians, it was written by one of the early French traders:

“Une fois qu'ils en auroient connula difference, on ne pourvoit plus leur en faire accepter d'autres”.

(Once they know the difference, they will not accept anything else.)

We know you will feel the same way about our Tulle “Fusil de Chasse”.



Specifications:

Lock Trigger & Tang Inletting Available

Overall length	57-1/2”
Pull length	15”
Drop at heel	3-1/2”
Barrel channel length	41”
Barrel channel size	3/4” round or out to round
Ramrod hole size	1-3/8” x 7”
Lock mortice area	1-3/4”
Butt	5-1/4” x 2-1/8”

Barrel .20 ga.	1” Octagon to Round	\$275.00
Appropriate Lock	L&R Early Flint	\$215.00
Appropriate Trigger	-	\$30.00
Appropriate Breech Plug	With Barrel	-
Recommended Buttplate	Steel	\$28.00
Recommended Triggerguard	Steel	\$33.00
Recommended Thimbles	(3)	\$24.00
Recommended Nose Cap	(none)	-
Lock Screws	(2)	\$3.50
Tang Screws	(1)	\$1.75
Rear Sight	(none)	-
Front Sight		\$12.00
Barrel Lugs	(3)	\$9.00
Barrel Keys (or Pins)	(3) Pins	N/C
Escutcheons	(none)	-
Toe Plate	(none)	-
Sideplate	-	\$18.00
Touch Hole Liner		\$3.00
Ramrod Jag & Tip		\$4.75
Ramrod		\$4.50
Misc. Screws		\$1.50
Stock Inletting & Drilling		\$82.50

Incl. Barrel Inlet & Buttplate Cut Barrel Breeched

Full Stock Prices: (Maple Grade)	Parts Total:	\$750.00
Curly Maple #1 \$170.00	Stock Price: (_____)	
Curly Maple #2 \$190.00	Grand Total: _____	
Curly Maple #3 \$250.00		
Curly Maple #4 \$325.00		
Curly Maple #5 \$450.00		
Cherry or Walnut \$235.00		



Arkansas Underhammer

Similar to the H & A Underhammer but different style action. Will accept barrels from 13/16" to 1-1/8" diameter and can easily interchange barrels.

Has a fine Trigger pull with direct ignition into the barrel stocks and forends are available in Curly Maple, Walnut and Cherry.

Can be used for rifle, shotgun or bench guns. Breech plugs are available in 5/8" x 18" & 3/4" x 16".

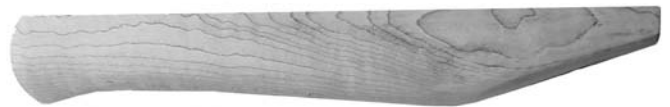

Grn. Mountain Barrel	\$225.00
Underhammer Action	\$205.00
*Pistol Grip Stock & Forearm - Optional	(\$160.00)
Walnut, Curly Maple, Cherry	
Butt Plate Steel Fine Checkered & Screws	\$30.00
Thimble (1 Round Steel)	\$4.00
Forearm Barrel Lug & Screws	\$10.00
Rear Sight	\$10.00
Front Sight	\$8.00
Flash Cup	\$4.00
Nipple	\$3.00
Ramrod Jag & Tip	\$4.75
Ramrod	\$4.50

Parts Total: \$665.25



H & A Underhammer

Many consider this to be a ugly rifle. Maybe it is, however it is simple and it works very well. Lock, trigger breech plug and trigger guard are all in one piece.

There is direct ignition into the barrel and has a fine trigger pull. Cap flash is out of view.

Various barrel sizes can be used on this action from 13/16" to 1-1/8".

Stocks and forends are available in walnut, cherry and curly maple. Stocks are inleted and drilled for the thru bolt.

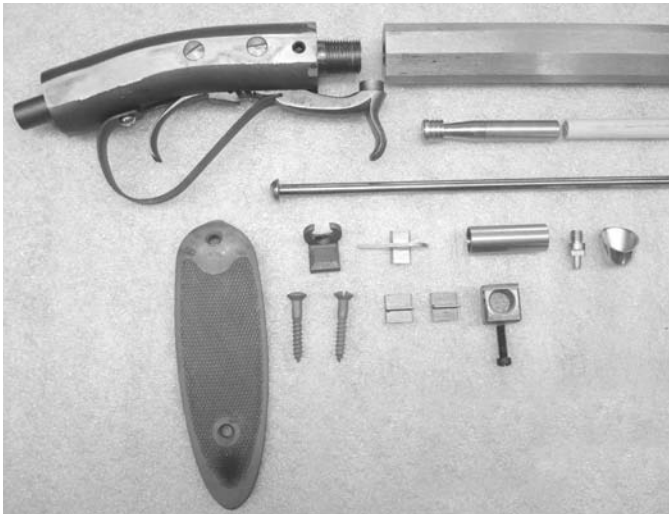

Grn. Mountain Barrel 36"	\$225.00
Underhammer Action H & A	\$185.00
Straight Grip Stock & Forearm	\$160.00
*Pistol Grip Stock & Forearm - Optional	\$160.00)
Walnut, Curly Maple, Cherry Inletted & Drilled for thru Bolt	
Butt Plate Steel Fine Checkered & Screws	\$30.00
Thimble (1 Round Steel)	\$4.00
Forearm Barrel Lug & Screws	\$10.00
Rear Sight	\$10.00
Front Sight	\$8.00
Flash Cup	\$4.00
Nipple	\$3.00
Ramrod Jag & Tip	\$4.75
Ramrod	\$4.50

Parts Total: \$647.75



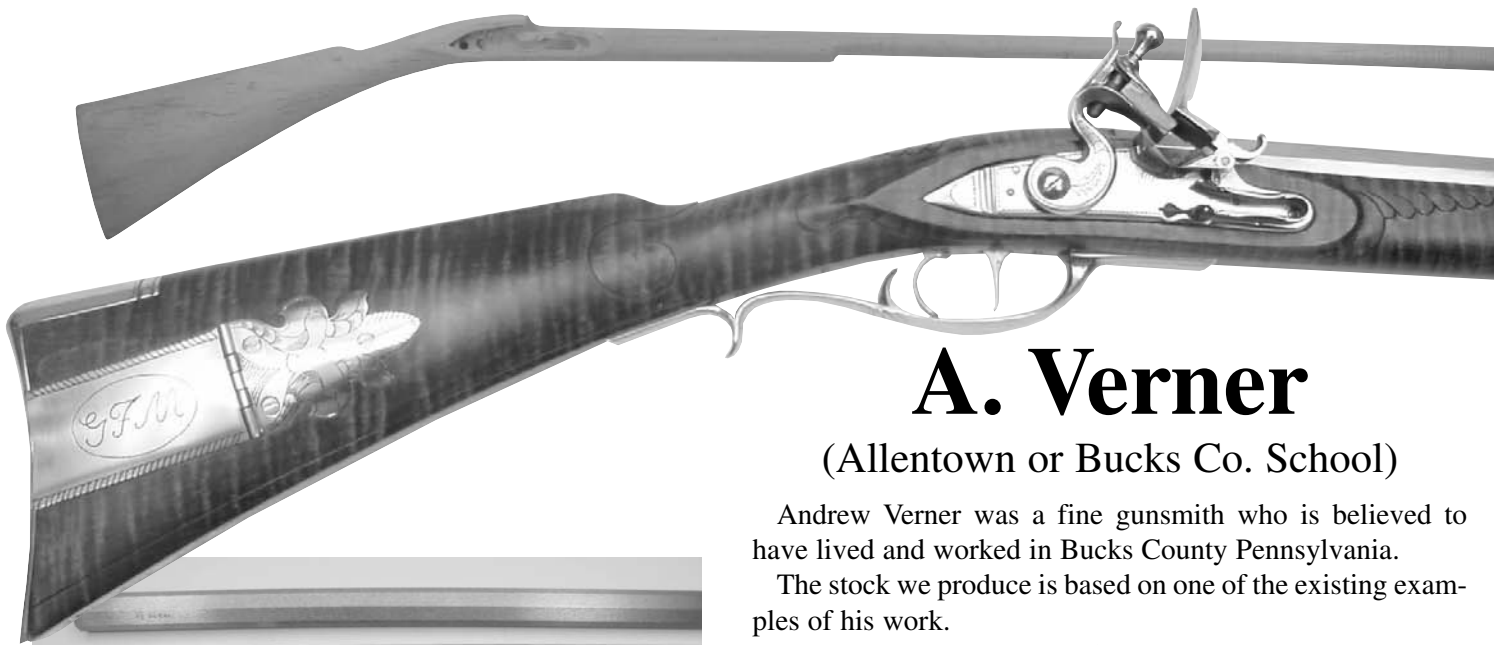

A. Verner

(Allentown or Bucks Co. School)

Andrew Verner was a fine gunsmith who is believed to have lived and worked in Bucks County Pennsylvania.

The stock we produce is based on one of the existing examples of his work.

The Buttplate is relatively flat, the stock is somewhat thick with a wrist that is wider than it is high. The comb of the stock is straight and the underside is slightly curved.

Verner is credited by some collecting authorities with beginning the Roman-nose profile that was also used by later gunsmiths.

The original rifle we used for our design had a heavy barrel. The wide Triggerguard was fastened with a screw.

The trigger is beautifully scaled and flows back toward the butt. This rifle was carefully carved with flowing lines into the stock, and it included a silver eagle inlay.

The wood used in the stock complemented the workmanship and was a fine grade of curly maple.

Building a rifle of this type will give you an appreciation for the craftsmanship of the early masters. The rifle design makes the wood seem to flow into the metal. This rifle deserves your careful and attentive efforts. When you successfully finish building this gun you will possess a firearm that will be envied and admired. It will be a work that future generations should cherish.

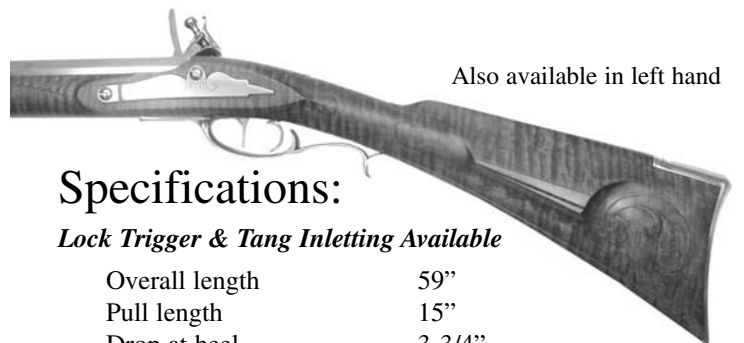

Also available in left hand

Specifications:

Lock Trigger & Tang Inletting Available

Overall length	59"
Pull length	15"
Drop at heel	3-3/4"
Barrel channel length	42"
Barrel channel size	13/16" or 7/8"
Ramrod hole size	3/8"
Lock mortice area	1-1/4" x 6-1/2"
Width at lock	1-5/8"
Butt	1-3/4" x 5-1/4"

**Available with Green Mountain swamped barrel \$180.00. Additional \$45.00 inletting for swamped barrel. (Deduct price of original barrel).



Grn. Mountain Barrel	13/16" & 7/8" x 42"	\$225.00
Appropriate Lock	L&R Classic Flint	\$215.00
*Optional Lock	*(L&R Classic Perc.	\$150.00)
Appropriate dbl. - set Trigger	Davis #4	\$65.00
Appropriate Breech Plug	Fantail	\$12.00
Recommended Buttplate	Brass	\$22.00
Recommended Triggerguard	Brass	\$22.00
Recommended Thimbles	Brass (3)	\$24.00
Recommended Nose Cap	Brass	\$12.00
Lock Screws	(2)	\$3.50
Tang Screws	(1)	\$1.75
Rear Sight		\$10.00
Front Sight		\$8.00
Barrel Lugs	(3)	\$9.00
Barrel Keys (or Pins)	(3) Pins	N/C
Escutcheons	Brass (6)	\$6.00
Toe Plate	Brass	\$6.00
Sideplate	Brass	\$9.00
Touch Hole Liner		\$3.00
Drum & Nipple		*(8.00)
Ramrod Jag & Tip	Brass	\$4.75
Ramrod		\$4.50
*Optional Patchbox		*(45.00)
Misc. Screws		\$1.50
Stock Inletting & Drilling		\$57.50

Full Stock Prices: (Maple Grade)

- Curly Maple #1 \$170.00
- Curly Maple #2 \$190.00
- Curly Maple #3 \$250.00
- Curly Maple #4 \$325.00
- Curly Maple #5 \$450.00
- Cherry or Walnut \$235.00

Parts Total:	\$721.50 (Flint)
Stock Price: (_____)	
Grand Total: _____	



Vincent Halfstock

A distinctive, very slim halfstock rifle with fine, sharp lines, built by John & Caleb Vincent from Ohio, who produced many guns over a period exceeding 70 years. Many have survived and are very collectible. Most stocks were of curly maple. Sometimes with mixed brass & German silver hardware.

Our Vincent stock is shaped in "The Vincent Style" with 13/16" - 7/8" and 15/16" barrel channels. Ramrod hole is drilled for 5/16" or 3/8". Most all original Vincent rifles had a 5/16" ramrod. We inlet the stock for a golcher percussion lock and double set trigger. A brass Vincent patchbox is an option.

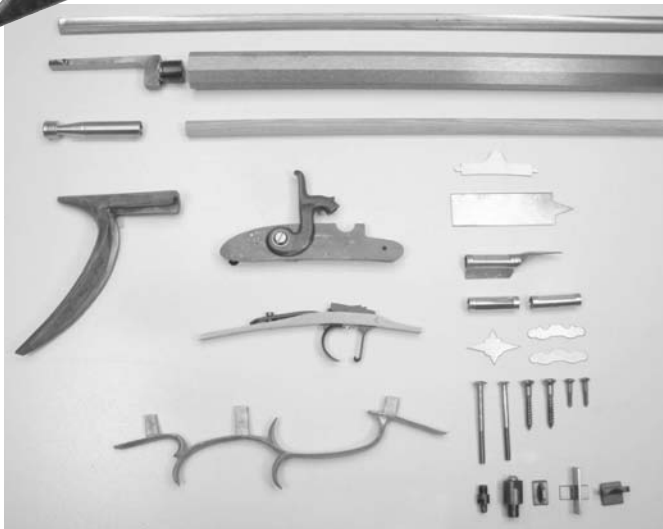

Grn. Mountain Barrel	13/16" & 7/8" x 36"	\$225.00
Appropriate Lock	Golcher Perc.	\$160.00
Appropriate dbl. - set Trigger	Davis #4	\$65.00
Appropriate Breech Plug	-	\$12.00
Recommended Buttplate	Brass	\$50.00
Recommended Triggerguard	Brass	\$50.00
Recommended Thimbles	Brass (3)	\$24.00
Recommended Nose Cap (none, should be poured)		-
Lock Screws	(1)	\$1.75
Tang Screws	(1)	\$1.75
Barrel Rib		\$36.00
Rear Sight		\$10.00
Front Sight		\$8.00
Barrel Lugs	(1)	\$3.00
Barrel Keys (or Pins)	(1) Pin	N/C
Escutcheons	(2)	\$2.00
Toe Plate		\$6.00
Sideplate		\$2.00
Drum & Nipple		\$6.00
Ramrod Jag & Tip		\$4.75
Ramrod		\$4.50
*Optional Patchbox		(\$50.00)
Misc. Screws		\$1.50
Stock Inletting & Drilling		\$57.50

Half Stock Prices: (Maple Grade)

Curly Maple #1	\$105.00
Curly Maple #2	\$120.00
Curly Maple #3	\$175.00
Curly Maple #4	\$215.00
Curly Maple #5	\$280.00
Cherry or Walnut	\$160.00

Parts Total:	\$730.75
Stock Price: (_____)	
Grand Total: _____	



Specifications:

Lock Trigger & Tang Inletting Available

Overall length	30"
Pull length	14"
Drop at heel	3-3/4"
Barrel channel length	13"
Barrel channel size	13/16" - 7/8" - 15/16"
Ramrod hole size	3/8" - 5/16"
Lock mortice area	1-1/2" x 5-3/4"
Width at lock	1-1/2"
Butt	1-1/4" x 4-3/8"



Virginia

Early style used from the French and Indian wars up to the Civil War. Available in straight or swamp barrel channels, and iron or brass hardware.

This is a heavier stock and large size barrels can be inletted.

Could be used with a smooth bore barrel as well as a rifled straight barrel.

We inlet this for the large Siler lock, Davis double set triggers and flared breech plug.

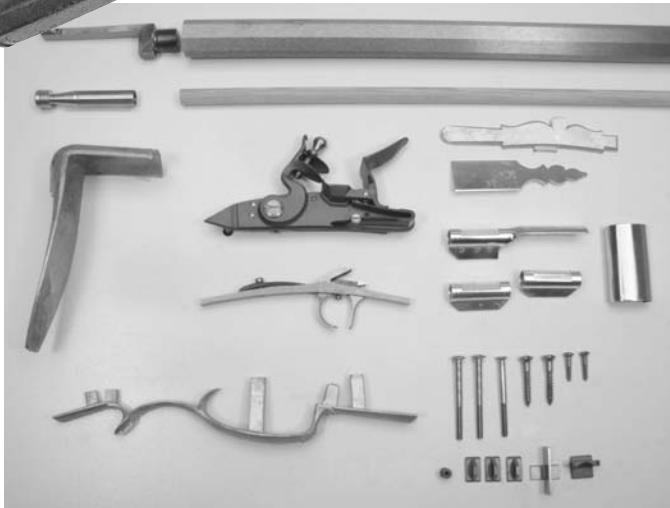

Grn. Mountain Barrel	7/8" - 15/16" - 1" x 42"	\$225.00
Appropriate Lock	L&R Classic Flint	\$215.00
*Optional Lock	*(L&R Classic Perc.	\$150.00)
Appropriate dbl. - set Trigger	Davis #4	\$65.00
Appropriate Breech Plug	Fantail	\$12.00
Recommended Buttplate	Brass	\$36.00
Recommended Triggerguard	Brass	\$36.00
Recommended Thimbles	Brass (3)	\$24.00
Recommended Nose Cap	Brass	\$12.00
Lock Screws	(2)	\$3.50
Tang Screws	(1)	\$1.75
Rear Sight		\$10.00
Front Sight		\$8.00
Barrel Lugs	(3)	\$9.00
Barrel Keys (or Pins)	(3) Pins	N/C
Escutcheons	Brass (6)	\$6.00
Toe Plate	Brass	\$5.00
Sideplate	Brass	\$9.00
Touch Hole Liner		\$3.00
Drum & Nipple		*(8.00)
Ramrod Jag & Tip	Brass	\$4.75
Ramrod		\$4.50
*Optional Patchbox		*(40.00)
Misc. Screws		\$1.50
Stock Inletting & Drilling		\$57.50

Specifications:

Lock Trigger & Tang Inletting Available

Overall length	59"
Barrel inlet	7/8", 15/16" and 1"
Ramrod hole drilled	3/8"
Standard barrel channel	42"
Butt width	2" x 5-1/4"
Lock area	1-1/2" x 7"
Drop at heel	2-1/2"
Trigger pull up to	14-1/2"

Note: We can furnish this stock with a 44" barrel channel. However, shipping charges are more because the extra length requires an oversize package.

Full Stock Prices: (Maple Grade)

Curly Maple #1	\$170.00
Curly Maple #2	\$190.00
Curly Maple #3	\$250.00
Curly Maple #4	\$325.00
Curly Maple #5	\$450.00
Cherry or Walnut	\$235.00

Parts Total:	\$748.50 (Flint)
Stock Price:	(_____)
Grand Total:	(_____)

Also available in left hand

Stock Blanks

Curly Maple, Walnut & Cherry

Fullstock blanks are 58"- 63" in length and halfstocks are 34"- 36" in length. Pistol blanks are large enough to make any normal pistol with up to 12" barrel.

All blanks are between 2-1/4" and 2-1/2" thickness. Blanks when cut have enough width and drop to allow for almost any style stock. All blanks are kiln dried to 6% to 8% moisture content.



Full Stock Blanks

CM1	Little or no curl	\$170.00
CM2	30 - 60% curl	\$190.00
CM3	65 - 85% curl	\$250.00
CM4	90 - 100% curl	\$325.00
CM5	Finest curl & figure	\$450.00
Walnut	All dark, no sapwood	\$235.00
Cherry	Dark cherry, no sapwood	\$235.00
Ash		\$210.00

Half Stock Blanks

CM1	\$105.00
CM2	\$120.00
CM3	\$175.00
CM4	\$215.00
CM5	\$280.00
Walnut	\$160.00
Cherry	\$160.00
Ash	\$140.00

Pistol Blanks

Straight Grain	\$50.00
CM4	\$110.00
Walnut	\$65.00
Cherry	\$65.00

Additional 25% for Sugar Maple

Shipping Half Stock blanks \$30.00

Shipping Full Stock blanks \$35.00

Barrel Channel & Ramrod Inletting for Stock Blanks

Cut Swamp Barrel Channel & Ramrod Groove	Full Stock	\$75.00
Cut Straight Barrel Channel & Ramrod Groove	Full Stock	\$45.00
Cut Straight Barrel Channel & Ramrod Groove	Half Stock	\$30.00
Cut Straight Barrel Channel & Ramrod Groove	Pistol Stock	\$30.00
Carve Customers Wood	Full Stock	\$120.00
Carve Customers Wood	Half Stock	\$95.00
Carve Customers Wood	Pistol Stock	\$45.00

Stocks

Remington Rolling Block

1. Pistol grip with cheek piece
2. Pistol grip
3. Straight grip with cheek piece

Winchester Model 85 (Hi-Wall)

1. Straight grip with crescent butt
2. Straight grip with shotgun butt
3. Straight grip with cheek piece and shotgun butt
4. Pistol grip with cheek piece and shotgun butt
5. Schuetzen with cheek piece cut for winchester swiss Buttplate

Martini

1. Cadet with cheek piece
2. Enfield with cheek piece
3. BSA

Ballard

1. Pistol grip with cheek piece
2. Straight grip
3. Schuetzen with cheek piece

Remington Hepburn With Pistol Grip

Winchester Model 76

Straight grip

Winchester Model 86

1. Straight grip
2. Pistol grip with cheek piece

Sharps Borchart

Stevens

1. Model 44
2. Model 44 1/2
3. Model 52

Boys Rifles

1. Remington model 6
2. Remington model 4
3. Stevens favorite

Forearms

1. Winchester hi-wall
2. Remington hepburn and rolling back
3. Stevens model 44 and 45

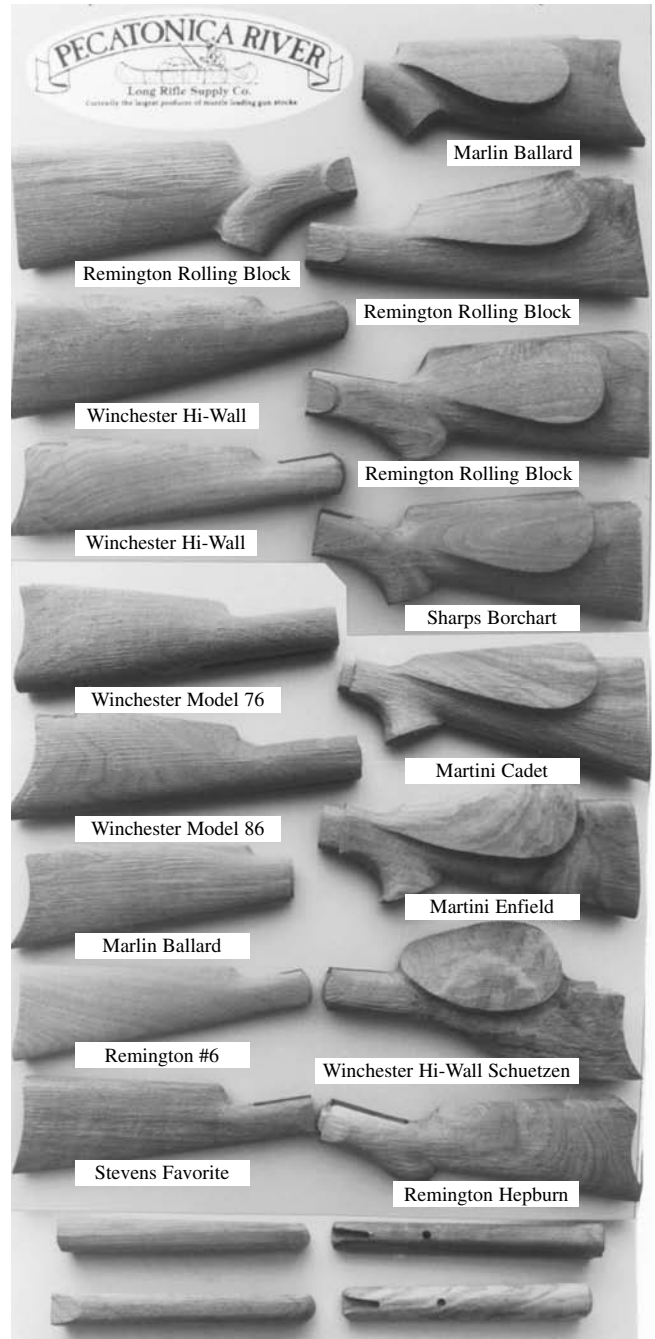

Standard Walnut - All Heartwood - Clear - No Defects

Straight grip butt stock	\$95.00
Pistol grip butt stock	\$105.00
Forearm shaped as original	\$55.00
Square forearm with 1" or 1 1/8"	
Barrel channel - you shape	\$30.00

Semi Fancy Walnut, Curly Maple and Claro Walnut

Butt stock - add to standard walnut prices	\$65.00
Forearm - add to standard walnut prices	\$25.00

Fancy Walnut: call for availability & price

Carve Your Wood To Our Pattern

Buttstock	\$85.00
Forearm	\$55.00

Bore buttstock for drawbolt	\$15.00
Set up charge to copy your pattern	\$30.00



Colerain Barrel Company, Inc.

6 Grooves, Round Bottom Cut Rifling .016 Deep

*Straight Octagon 1137 Steel
8 Grooves .010 to 0.12 Depth*

Size	Caliber	Length	Twist Gr. Mtn.	Twist Colerain	Threads	Price Gr. Mtn. Colerain	Price Rice
3/4"	.32	42"		1-48	9/16" x 18"	\$225.00	\$250.00
3/4"	.36	42"		1-48	9/16" x 18"	\$225.00	\$250.00
3/4"	.40	42"		1-48	9/16" x 18"	\$225.00	\$250.00
13/16"	.32	42"		1-48	5/8" x 18"	\$225.00	\$250.00
13/16"	.36	42"	1-48	1-48	5/8" x 18"	\$225.00	\$250.00
13/16"	.40	36"	1-60	1-48	5/8" x 18"	\$225.00	\$250.00
13/16"	.40	42"	1-60	1-48	5/8" x 18"	\$225.00	\$250.00
13/16"	.45	36"	1-60	1-56	5/8" x 18"	\$225.00	\$250.00
13/16"	.45	42"	1-60	1-56	5/8" x 18"	\$225.00	\$250.00
7/8"	.45	42"	1-60	1-48	5/8" x 18"	\$225.00	\$250.00
7/8"	.50	36"	1-70	1-56	5/8" x 18"	\$225.00	\$250.00
7/8"	.50	42"	1-70	1-56	5/8" x 18"	\$225.00	\$250.00
15/16"	.40	42"	1-48	1-48	5/8" x 18"	\$225.00	\$250.00
15/16"	.45	42"	1-60	1-56	5/8" x 18"	\$225.00	\$250.00
15/16"	.50	36"	1-70	1-56	5/8" x 18"	\$225.00	\$250.00
15/16"	.50	42"	1-70	1-56	5/8" x 18"	\$225.00	\$250.00
15/16"	.54	36"	1-70	1-56	5/8" x 18"	\$225.00	\$250.00
15/16"	.54	42"	1-70	1-56	5/8" x 18"	\$225.00	\$250.00
1"	.50	34"	1-28	-	3/4" x 16"		
1"	.50	36"	1-70	1-56	3/4" x 16"	\$225.00	\$250.00
1"	.54	36"	1-70	1-56	3/4" x 16"	\$225.00	\$250.00
1"	.58	36"	1-70	1-66	3/4" x 16"	\$225.00	\$250.00



Colerain Barrel Company, Inc.

*Smooth Bore Barrels 1" at Breech
Tulle – Northwest Trade Gun – Fowler Barrels
Octagon & Round 3/4 x 16 Thread
Breech Plug Installed
Rifled Barrels Additional \$40*

Caliber / Gauge	Barrel Length	Price
54 Caliber / 28 Gauge	36"	\$275.00
54 Caliber / 28 Gauge	42"	\$275.00
58 Caliber / 24 Gauge	36"	\$275.00
58 Caliber / 24 Gauge	42"	\$275.00
62 Caliber / 20 Gauge	36"	\$275.00
62 Caliber / 20 Gauge	42"	\$275.00
62 Caliber / 20 Gauge Turkey Choke	38"	\$275.00



Muzzleloader Pistol Barrel Blanks

Black Powder Only • Straight Octagon 1137 Steel • 8 Grooves .008" to .010" Depth

Size	Caliber	Twist	Length	Threads	Price
13/16"	.40	1-16	11"-12"	5/8" x 18"	\$125.00
13/16"	.45	1-20	11"-12"	5/8" x 18"	\$125.00
7/8"	.45	1-20	11"-12"	5/8" x 18"	\$125.00
7/8"	.50	1-20	11"-12"	5/8" x 18"	\$125.00
15/16"	.54	1-20	11"-12"	5/8" x 18"	\$125.00

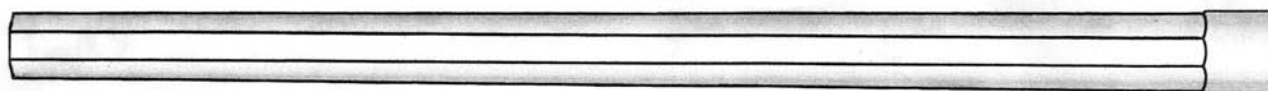

Black Powder Cartridge Barrels

Winchester Octagon Tapers • 4140 Chrome Moly Steel, Button Rifled, Air Gaged, Stress Relieved, 35" Long

Caliber	Style	Bore	Groove	Twist	Weight	Price
.22	#2- 1.00 x .85	.218	.223	1-16		\$380.00
.38-.55	Honed #3- 1.05 x .95	.368	.375	1-14		\$405.00
.38-.55	Honed #3- 1.05 x .95	.368	.375	1-12	6.78	\$405.00
.40-.65	Honed #3- 1.05 x .95	.400	.408	1-16	6.63	\$405.00
.45-.70	Honed #3- 1.05 x .95	.450	.458	1-18	6.55	\$405.00
.45-.70	Honed #4- 1.12 x 1.08	.450	.458	1-18	8.28	\$405.00

Straight Octagon 1137 Steel
8 Grooves .010 to 0.12 Depth



6 Grooves, Round Bottom Cut Rifling .016 Deep
Breech Plugs Installed – Finish Grounded

44" SWAMPED AMERICAN HERITAGE STYLE

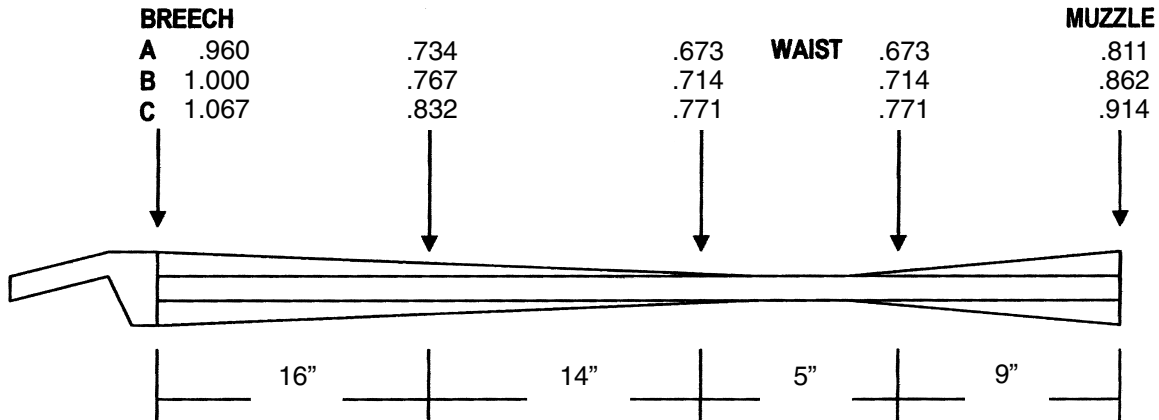

Size	Caliber	Length	Twist Gr. Mtn.	Twist Colerain	Threads	Price Rice	Price Colerain
A	.32	44"	1-48		9/16" x 18"	\$320.00	
A	.36	44"			9/16" x 18"	\$320.00	\$275.00
A	.40	44"		1-48	5/8" x 18"	\$320.00	\$275.00
B	.45	44"		1-56	5/8" x 18"	\$320.00	\$275.00
B	.50	44"		1-56	5/8" x 18"	\$320.00	\$275.00
C	.54	44"		1-56	5/8" x 18"	\$320.00	\$275.00

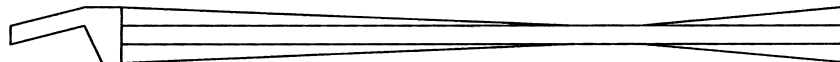

Colerain – Jeager Swamped Barrels

50, 54, 58, 62 cal. 1-1/16" at breech, 31" long.
Breech plug installed **\$275.00 • Rice \$320.00**

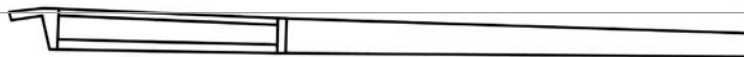

Colerain Harpers Ferry Barrel

54 cal. Octagon to round, 33" long. Breech plug installed. **\$275.00 • Rice \$320.00**



Blunder Bus Barrel

75 cal. 1-1/8" Octagon at breech, 20" long. Breech plug installed. **\$295.00**
10 ga. 1-1/8" Octagon at breech, 20" long. Breech plug installed. **\$485.00**
4 ga. 1-1/8" Octagon at breech, 20" long. Breech plug installed. **\$485.00**



Rifle Barrel Co. Inc.

*Straight Octagon 1137 Steel
8 Grooves .010 to 0.12 Depth*



COLERAIN BARREL COMPANY, INC.

*6 Grooves, Round Bottom Cut Rifling .016 Deep
Breech Plugs Installed – Finish Grounded*

38" SWAMPED EARLY AMERICAN STYLE

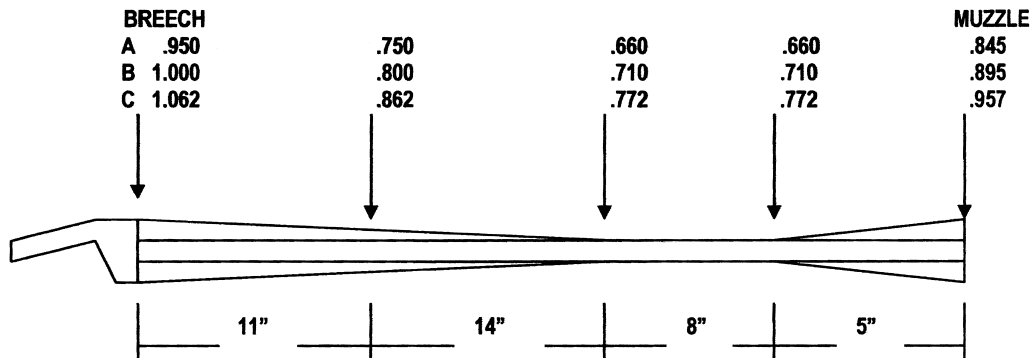

Size	Caliber	Length	Twist	Twist Colerain	Threads	Price Rice	Price Colerain
A	.36	38"		1-48	9/16" x 18"	\$320.00	\$265.00
A	.40	38"		1-48	5/8" x 18"	\$320.00	\$265.00
B	.45	38"		1-56	5/8" x 18"	\$320.00	\$265.00
B	.50	38"		1-56	5/8" x 18"	\$320.00	\$265.00
C	.54	38"		1-56	3/4" x 16"	\$320.00	\$265.00

42" SWAMPED CLASSIC AMERICAN STYLE

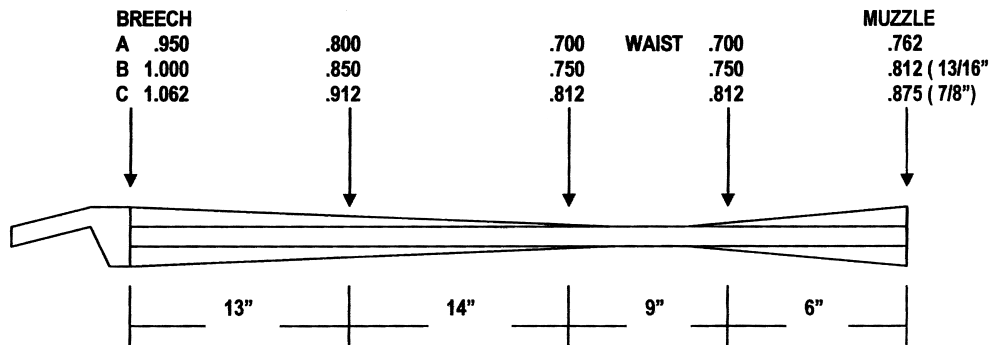

Size	Caliber	Length	Twist	Twist Colerain	Threads	Price Rice	Price Colerain
A	.36	42"		1-48	9/16" x 18"	\$320.00	\$270.00
A	.40	42"		1-48	5/8" x 18"	\$320.00	\$270.00
B	.45	42"		1-56	5/8" x 18"	\$320.00	\$270.00
B	.50	42"		1-56	5/8" x 18"	\$320.00	\$270.00
C	.54	42"		1-56	5/8" x 18"	\$320.00	\$270.00
C	.58	42"		1-56	3/4" x 16"	\$320.00	\$270.00

Breech Plugs



Straight Tang Breech Plugs

Milled from solid bar stock, these straight tang plugs are available in all standard American threads for barrels from 3/4" to 1-1/8" in diameter. The tang on this standard plug is approximately 3" long and is appropriate for Golden Age and later rifles and pistols.

9/16-18 threads for 3/4" diameter barrels	\$12.00
9/16-18 threads for both 13/16" and 7/8"	\$12.00
5/8-18 threads for both 13/16" and 7/8"	\$12.00
5/8-18 threads for both 15/16" and 1"	\$12.00
3/4-16 threads for both 15/16" and 1"	\$12.00
3/4-16 threads for both 1" and 1 1/8"	\$12.00
7/8-14 threads for 1 1/8" diameter	\$12.00

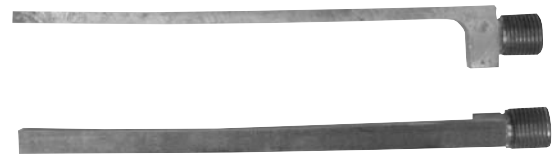

Long Tang Breech Plugs

Milled from solid bar stock, these extra long straight tang plugs are available in all standard American threads for barrels from 13/16" to 1" in diameter. The tang on this standard plug is approximately 6-3/4" long and is appropriate for Tennessee, Carolina and Southern Mountain rifles. Slightly shorter versions of the long tang appear on many Kentucky longrifles.

9/16-18 threads for both 13/16" and 7/8"	\$14.00
5/8-18 threads for both 13/16" and 7/8"	\$14.00
5/8-18 threads for both 15/16" and 1"	\$16.00
3/4-16 threads for both 15/16" and 1"	\$16.00

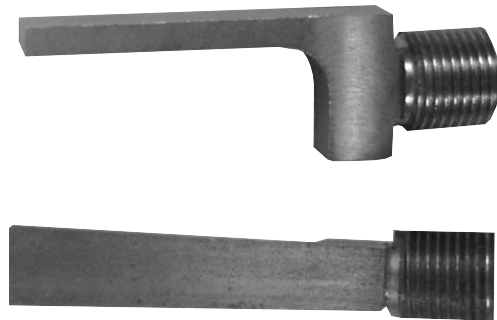

Flared Tang Breech Plugs

Milled from solid bar stock, these flared tang plugs are available in all standard American threads for barrels from 3/4" to 1-1/8" in diameter. Tang on this plug is approximately 2-1/4" long. Appropriate for early rifles.

9/16-18 threads for 3/4" dia. barrels	\$12.00
9/16-18 threads for both 13/16" and 7/8"	\$12.00
5/8-18 threads for both 13/16" and 7/8"	\$12.00
5/8-18 threads for both 15/16" and 1"	\$12.00
3/4-16 threads for both 15/16" and 1"	\$12.00
3/4-16 threads for both 1-1/16" - 1-1/8"	\$15.00

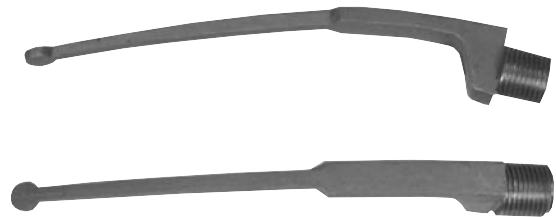

Tennessee "Lollipop" Breech Plugs

These extra long "Lollipop" tang plugs are investment cast and are close reproductions of plugs found on original Tennessee longrifles. Available in standard American threads for barrels from 13/16" to 1" in diameter. The tang on this standard plug is approximately 6-3/4" long and is appropriate for Tennessee, Carolina and Southern Mountain rifles.

9/16-18 threads for both 13/16" and 7/8"	\$24.00
5/8-18 threads for both 13/16" and 7/8"	\$24.00
5/8-18 threads for both 15/16" and 1"	\$24.00
3/4-16 threads for both 15/16" and 1"	\$24.00

Breech Plugs



Hooked Breech Plug & Tang for Flint

The quality of these pre-fit hooked breech plugs is exceptional. X-Rayed for safety. This set is appropriate primarily for early style Hawken fullstock rifles. **\$90.00 set**

5/8"-18, Flint Plug & Tang Set for 15/16" Bbls.

3/4"-16 Thds, Flint Plug & Tang Set for 1" Barrels

Breech Plug only \$56.00

Tang only \$34.00

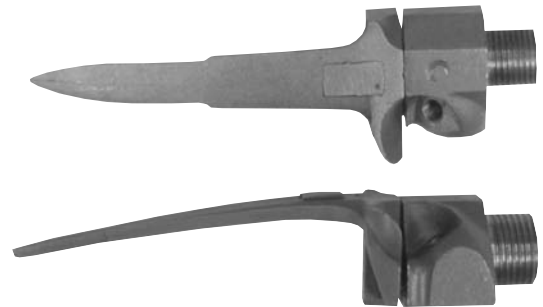

English Hooked Breech Plug & Tang

Used on English sporting rifles and target guns, these are intended to be used with a lock which requires a bar to complete the fit to the barrel. It can be filed to accept other lock types. **\$70.00 per set of 1 plug and tang.**

5/8"-18, Snail Plug & Tang Set For 13/16" Barrels

5/8"-18, Snail Plug & Tang Set for 15/16" Barrels

3/4"-16, Snail Plug & Tang Set for 1" Barrels



Percussion Hooked Breech Plugs

These pre-fit plug and tang sets are intended for use on plains rifles and Hawkens in the last days of the black powder era. They are high quality investment castings, X-Rayed for safety and quality, and are made as close reproductions of plugs found on original rifles. Available in standard American threads for barrels from 15/16" to 1-1/8" in diameter. **\$90.00 set.**

5/8"-18 Thd, Plug & Tang Set for 15/16" barrels

(This plug fits L&R Locks Model 125)

3/4"-16 Threads, Plug & Tang Set for 1" barrels

(This plug fits L&R Locks Model 125)

Breech Plug only \$56.00

Tang only \$34.00



Percussion Hooked Breech Plugs

This plug is for fitting to a Thompson Center tang to fit American standard size threads on American barrels like Green Mountain, Rayl or any of like sizes as shown. Tang is not currently available.

5/8"-18 Threaded Plug for 15/16"

Diameter Barrels \$55.00

3/4"-16 Threaded Plug for 1"

Diameter Barrels \$55.00

Jim Chambers Siler Locks

Siler locks are a Germanic style created many years ago by Bud Siler to fill a void in the muzzleloading world. This lock line was later purchased by Jim Chambers, Inc., and soon after some needed design modifications, became one of the most sought after locks in the business. They are generally the first choice of builders worldwide because of their inherent long lasting durability, and quality of construction. They are well suited for many rifles and pistols found in the golden age of muzzleloading which fall in the 1770 to 1790's.



Large Siler Flintlocks

The original Siler lock is a copy of the Germanic styled, hand-forged locks used by mid to late 18th century gunmakers. This style was common to 1770 to 1790 period rifles made by such well known builders as Jacob Dickert, Isaac Haines, J.P. Beck and many others. The plate measures 5-1/4" x 1" and uses 7/8" x 3/4" flints. The flintlock is completely interchangeable with its percussion version. If you are going to possibly interchange locks, always build for the percussion drum first. Then all you have to change is a touch hole liner of the same thread; preferably, of 5/16" x 24" threads for the flint.

Large Siler Flint Right Hand \$295.00

Large Siler Flint Left Hand \$295.00



Small Siler Flintlock

The small Siler flintlock fits the same time period as the large Siler flintlock 1770-1790. Its smaller size makes this lock ideal for small or very fine lined rifles or pistols. Measures 4-3/4" x 7/8" and uses 3/4" wide flints. The small Siler flint and percussions are fully interchangeable with each other.

Small Siler Flint Right Hand \$295.00

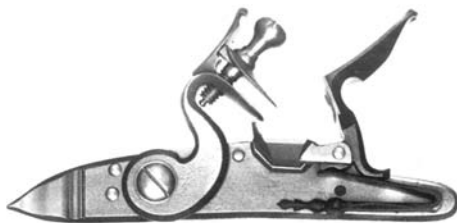

Golden Age Flintlock

Classic flintlock from the 1770 to 1800 period. Closely related to the large siler lock. The lock plate is longer and the cock is taller than the large siler. Most internal parts are shared with the siler. Very fast lock. Lock is 5-9/16" long by 15/16", and uses 3/4" flints. **\$295.00**



Large Siler Percussion

As percussion ignition came into use, many original flintlocks were converted to this new system. The original lock plate was retained, but the flint hammer, frizzen, and frizzen spring were replaced by a percussion hammer, drum and nipple. These large caplocks are completely interchangeable with the Siler large flintlock for those of you who want to interchange. Plate cut for a 1/2" drum.

Large Siler Percussion Right Hand \$230.00

Large Siler Percussion Left Hand \$230.00



Small Siler Percussion

Identical in size and interchangeable with the small Siler flint, this lock plate has a cutout for a 7/16" diameter drum.

Small Siler Percussion Right Hand \$230.00



Golden Age Percussion

True flintlock conversion to percussion. Interchangeable with the Golden Age Flint. Fine quality early percussion lock. Lock is 5-9/16" long by 15/16". Takes a 1/2" inch drum. **\$230.00**

Jim Chambers Locks

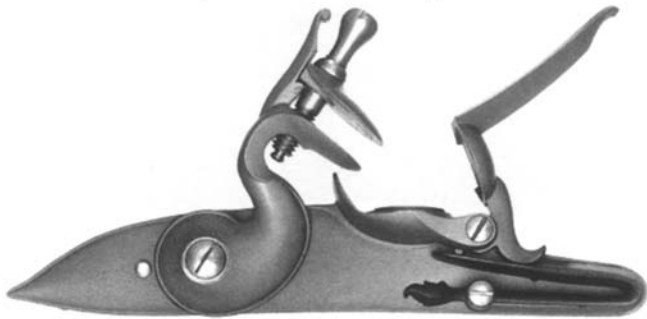

Round Face English Fowler Flintlock

Found on colonial American longrifles and fowlers. Features a decorative molding around the lock plate, and hammer has a raised weather proof pan. Lock is 6" x 1" and uses 7/8" inch flints. **\$295.00**

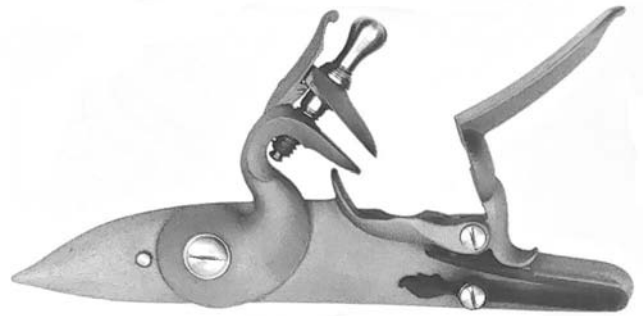

Colonial Virginia Flintlock

Locks of this type were made in England during the 1740's, 1750's and 1760's. Exported to the Colonies, they were used on Rifles, Fowlers and Trade guns made in Virginia, Maryland and the Carolinas. Lock is 6" long x 1", uses 7/8" Flints. **\$295.00**

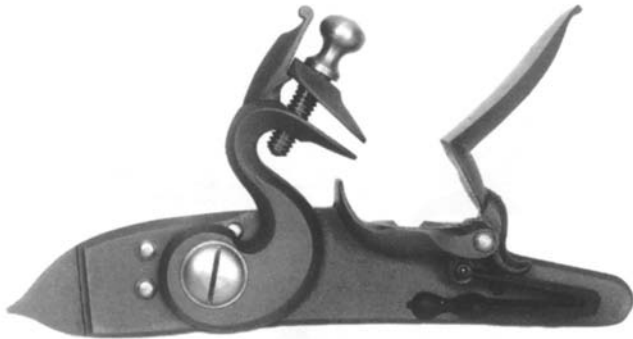

Late Ketland Flintlock

Golden age era lock ideal for use on American long rifles. Features a roller on the frizzen spring and uses internal parts from the large siler lock. Fast and reliable lock. Lock is 5" long by 15/16" and uses 3/4" inch flints. **\$295.00**

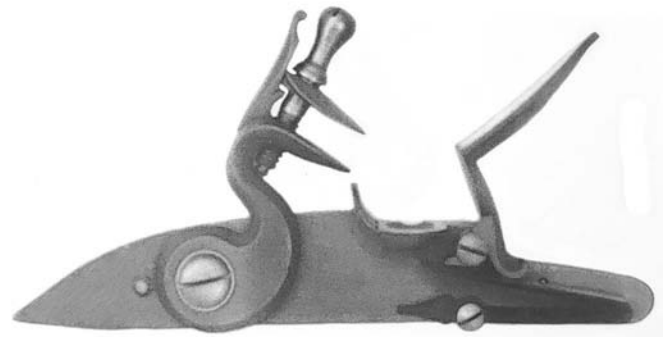

Early Ketland Flintlock

Produced in England during the 1760's and 1770's and exported to America. Used on rifle's Fowler and Trade guns produced during the last half of the 18th century. Lock is 5-3/4" long x 1", uses 7/8" Flints. **\$295.00**

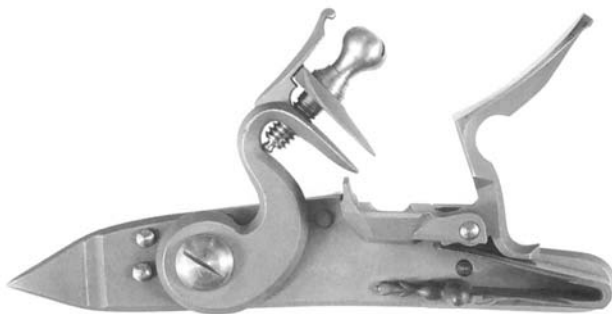

Deluxe Siler Flintlock, Model #L-18

Need to replace a standard Siler lock? Or do you have a pre-carved stock already inlet for a large Siler? Or do you just want something a little better than the standard Siler lock? The Deluxe Siler uses the standard Siler plate, but incorporates the taller hammer, different tumbler and fancy frizzen spring from the Golden Age lock for improved performance. Lock is 5-1/4" long by 1" and uses 7/8" x 3/4" inch flints. **\$295.00**

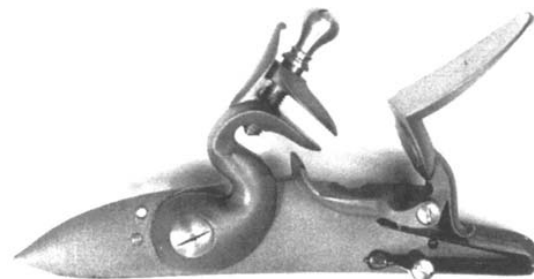

Small Queen Anne Flintlock

Smaller than the small Siler lock. Rounded plate, pan and hammer. Perfect for use on early flint pistol, Dueling pistols or small caliber flint rifle. Size: 5" x 7/6". Recommended flint size 3/4". **\$295.00**

L&R Locks



L&R Classic Flintlock - Bridled Frizzen

The Classic locks have all the features which are appropriate for several rifle styles. Each Classic has a fly in the tumbler and a roller on the frizzen. Thick bolster area for proper stock profiling fits same lock mortice as large siler. Recommended flint size 3/4" Size: 5-3/8" x 1"

L&R Model 2100 Flint Right Hand \$215.00
L&R Model 2175 Flint Left Hand \$215.00



L&R Classic Percussion Lock

This is the percussion version of the L&R Classic series of locks and is completely interchangeable with the Classic Flintlock. It is styled to accurately portray what a flintlock converted to percussion would have looked like of the period with its cut-away pan. Size: 5-3/8" x 1", same as flint. Uses 1/2" drum.

L&R Model 2100P Percussion Right Hand \$150.00
L&R Model 2175P Percussion Left Hand \$150.00



L&R Trade Gun Flintlock

This lock could be used on a Fowler or trade gun as well as other early longrifles of the mid to late 18th century. Manufactured by both the French and English, they were very plain and simple and common to the Indian trade rifle. Size: 5-5/8" x 1-1/8". Right hand only. Recommended flint size 3/4".

L&R Model 2200 \$215.00

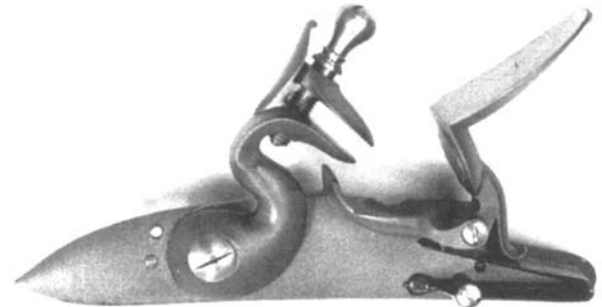

L&R Queen Anne Flintlock

Copied from a nice original pistol and up-sized for versatility. From the 1740-1750 period and would be appropriate for trade guns, Fowlers and other early rifles with English traits. Size: 5-9/16" x 1-1/6". Recommended flint size 3/4" right hand only.

L&R Model 2000 Right Hand \$215.00
L&R Model 2075 Left Hand \$215.00



L&R Schuetzen Percussion Lock

An excellent German and American Schuetzen style lock. Polished plate inside and out. Design produces a very short but powerful stroke. Plate measures 5" x 1-1/16" in right hand only.

L&R Model 575 \$150.00



L&R Back-Action Percussion Lock

Extremely fast lock time, late developed style of lock used from mid to late 1800's. Often used on halfstock rifles and shotguns.

L&R Model 700 Right Hand \$150.00
L&R Model 800 Left Hand \$150.00

L&R Locks



L&R Bedford Flintlock

Bedford County rifles are among the most distinctive styles and require a lock that is true to the period and location. Only L&R makes the proper lock for a Bedford rifle. Available in percussion as well, each can interchange. Right hand only. Size: 5-7/16" x 7/8". Recommended flint size 5/8".

L&R Model 1900 Flint \$215.00



L&R Bedford Percussion Lock

The Bedford percussion lock was copied from an original "John Amos' rifle. This lock has the internals of the Manton and is another fast lock. Dimensions are same as the flintlock in right hand only. 7/16" drum. Size: 5-7/16" x 7/8".

L&R Model 1900 Percussion \$150.00



L&R Durs Egg Flintlock

Durs Egg was a master English gunmaker. This copy of an original lock features a waterproof pan, pierced bridle, fly in the tumbler, stirrup-type mainspring, and a roller mounted frizzen on an internally polished plate. Available in both left and right hand models. Size: 5" x 15/16". Recommended flint size 3/4".

L&R Model 1100 Right Hand \$215.00

L&R Model 1150 Left Hand \$215.00



L&R Durs Egg Percussion Lock

This is the percussion version of the L&R Durs Egg and has the same external dimensions for ease of interchange. Available in left or right hand. 7/16" Drum.

L&R Model 1100P Right Hand \$150.00

L&R Model 1150P Left Hand \$150.00



L&R Manton Flintlock

Available in both left and right hand and is good for fine double guns. This lock was copied from an original lock by a master English gunmaker. Features a waterproof pan and roller-mounted frizzen. A fast lock! Excellent for smaller size rifles & pistols. Size: 4-3/8" x 7/8"

L&R Model 1700 Flint Right Hand \$215.00

L&R Model 1800 Flint Left Hand \$215.00



L&R Manton Percussion Lock

This lock is the percussion version of the Manton with identical sized plates for easy interchange. Plate is cut for 7/16" drum. Ideal for small rifles and pistols. Size: 4-3/4" x 7/8"

L&R Model 1700P Right Hand \$150.00

L&R Model 1800P Left Hand \$150.00

L&R Locks

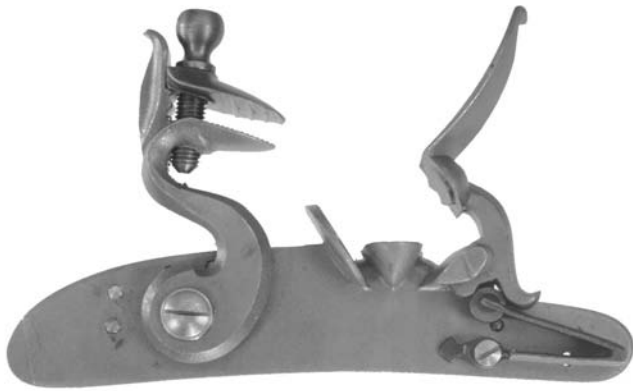

L&R Late English Flintlock with Goose Neck Hammer

Goose neck hammer for installing on late flint American rifles. In both left and right hand models as well. Appropriate for early Hawken rifles. This lock is interchangeable with the Leman percussion lock right hand, or left hand. Recommended flint size 5/8".

L&R Model 900 Flint Right Hand \$215.00

L&R Model 1000 Flint Left Hand \$215.00

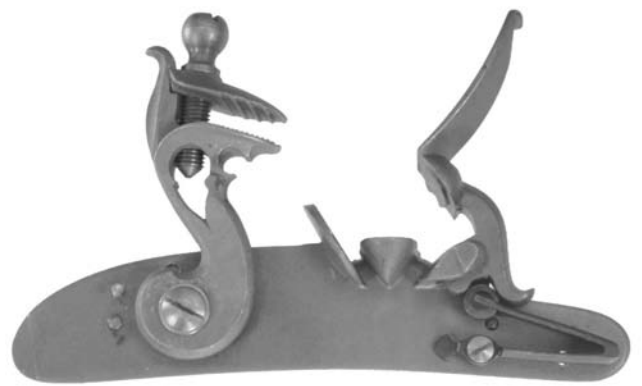

L&R Late English Flintlock with Double Throat Hammer

Appropriate for early styled fullstock Hawken rifles, Leman, Southern Mountain, Tennessee and other Mountain rifles as well as English and fowler long rifles. Lock plate is 5" x 1" and has a waterproof pan, roller on the frizzen spring, stirrup-type mainspring and fly. This lock interchanges with the L&R Leman percussion lock. Recommended flint size 5/8".

L&R Model 900DT Right Hand \$215.00

L&R Model 1000DT Left Hand \$215.00

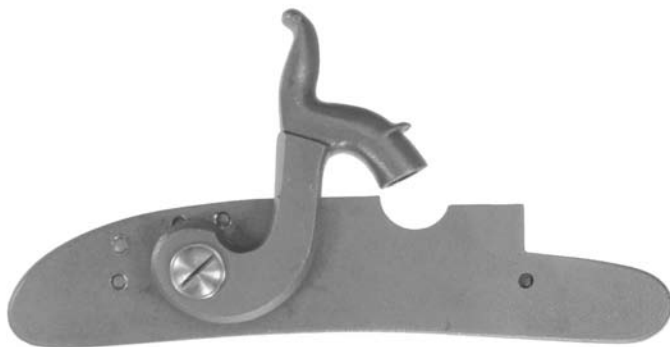

L&R Leman Percussion Lock

This lock is completely interchangeable with the earlier flintlock style Late English shown above. Uses a 1/2" drum. To facilitate the change, use a 5/16-24 threaded drum and touch hole liner. Plate measures 5" long x 1". Fly on the tumbler and stirrup-type mainspring. All lock internals are the same.

L&R Model 300 Right Hand \$150.00

L&R Model 400 Left Hand \$150.00

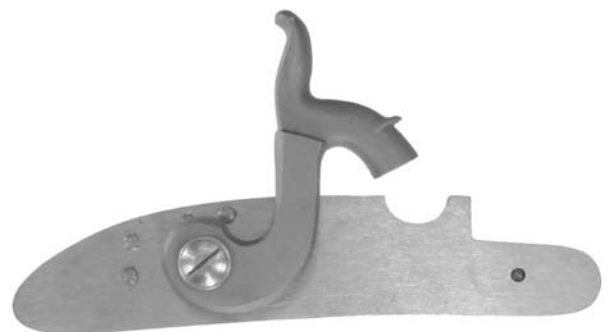

L&R Hawken "Warranted" Percussion Lock

Lock style typically found in early Hawken and other halfstock rifles. Imported from England they were commercially available to gunmakers. Size: 4-5/8" x 1".

L&R Model 150 Right Hand \$150.00



L&R T. Gibbons Hawken Percussion Lock

Copied from an original T. Gibbons lock on an original Hawken, this lock was designed for a snail breech. It mates perfectly to the L&R hooked breech & tang for 15/16", and 1" barrels. Polished plate measure 4-7/8" x 1". Right Hand Only.

L&R Model 125 Right Hand \$150.00



L&R Hawken Uncut Percussion Lock

Uncut version of the re-created T. Gibbons Hawken rifle lock. Will allow you to cut in your own fit to either drum or snail breech. This lock is identical in size and mechanical parts to the Gibbons lock. Both have the stirrup-fit mainspring and fly on the tumbler necessary for use with all double set triggers. This uncut lock is available in both left and right hand.

L&R Model 100 Right Hand \$150.00

L&R Model 200 Left Hand \$150.00

L&R Locks



L&R Shotgun Percussion Lock (With English Style Hammer)

This L&R percussion fowling lock is of the late English style. They were used on high quality double rifles, shotguns, and gentlemen's deer stalking rifles. The lock has a tumbler fly and stirrup-type mainspring. Size: 5" x 1"

L&R Model 500 Right Hand \$150.00
L&R Model 600 Left Hand \$150.00



L&R New 750 Pistol Kit

Includes lock 3-1/8" x 7/8". Breech plug 7/8" with 5/8" x 18 threads. Trigger plate has pineapple finial and the trigger guard is available in brass and german silver.

L&R 750 Pistol Kit \$200.00



Arkansas Underhammer Action

Similar to the H & A Underhammer but different style action. Will accept barrels from 13/16" to 1-1/8" diameter and can easily interchange barrels. Has a fine Trigger pull with direct ignition into the barrel stocks and forends are available in Curly Maple, Walnut and Cherry. Can be used for rifle, shotgun or bench guns. Breech plugs are available in 5/8" x 18" & 3/4" x 16".

\$205.00



H&A Under Hammer Action

Hopkins and Allen type action with lock, trigger, breech plug and trigger guard all assembled. Threaded for 5/8" x 18" or 3/4" x 16" breech plug. Can use barrels or 13/16" - 7/8" - 1 5/16" - 1" or 1 1/8".

\$185.00

R.E. Davis Locks



Jaeger Flintlock by R.E. Davis

A dependable high quality flintlock for recreating very early Germanic and transitional rifles such as the Edward Marshall longrifle. Originally designed by Jack Haugh, Uses 7/8" wide flints. Size: 6" x 1".

Davis Jaeger Flint \$210.00
Davis Jaeger Percussion \$210.00



1803 Harpers Ferry Flintlock

The lock plate and all external parts of this flintlock have been reproduced from an original! The internals are time tested Davis standard parts for long-lasting durability. Available in right hand only and measures 5-1/4" x 1".

1803 Harpers Ferry Flint \$215.00



Early English Flint Lock

– by Davis. This “round faced” lock is designed and styled after early English prototypes. These locks, in various grades, were exported to America from 1750 to 1780. Appropriate for a mid-18th century era long rifle or fowler. Surface of lock is cast with the floral engraving common to these locks. High quality. Plate is 6-1/16" long, 1-1/8 wide. Right hand only.

Early English Flint Lock \$210.00



Goulcher Percussion Lock

One of R.E. Davis Companies best lock reproductions. This lock is an exact reproduction of an original Goulcher (shown above with the drum cut out in the plate) and is complete with “cast in” Goulcher trade mark insignia and engraving as on the originals. Lock is available with drum cut-out as shown cut for drum. Lock plate measures 4-3/4" x 15/16".

Davis Goulcher Percussion \$160.00

L&R Triggers

L&R Hawken Trigger

The L&R Hawken trigger is offered with a choice of two front trigger styles: curved or straight. It is double lever, double set and can be shot set or unset. These plates measure 9-3/4" by 1/2".



**L&R Hawken Double Set
Curved Front Trigger T-1400 \$82.50**



**L&R Hawken Double Set
Straight Front Trigger T-1300 \$82.50**



**L&R Tennessee Double Set Trigger
Model T-7**

Tennessee styled double lever, double set triggers on 3/8" wide x 5-1/2" long bar, fully adjustable. Ground finish on the bar with as cast in the black curved rear, and Tennessee re-curve front trigger. Needs a deeper bow trigger guard for good fit.

L&R Double Set Tennessee T-5 Trigger \$65.00



L&R Single Triggers

These triggers are available for both rifle with the long bar and pistol, the short bar. Mainly for Lemah and other trade guns, Southern and shotguns. They are a fairly long slim trigger with high knife and pin locations. Long bar measures 4-3/4" long, short bar is 2 3/4" long, both plates are 7/16" wide and have rounded ends.

L&R Single Trigger - Long Plate Model T-1600 \$30.00



L&R Single Triggers

These triggers are available for both rifle with the long bar and pistol, the short bar. Mainly for Lemah and other trade guns, Southern and shotguns. They are a fairly long slim trigger with high knife and pin locations. Long bar measures 4-3/4" long, short bar is 2-3/4" long, both plates are 7/16" wide and have rounded ends.

L&R Single Trigger - Short Plate Model T-1500 \$30.00

R.E. Davis Triggers



**Small Davis Double Set Trigger
Model 004**

This is the most popular trigger of the Davis line. It features smaller, finer triggers for ease of fit into most any style rifle and guard. Technical: triggers extend max 15/16" below plate, bar measures 5-1/4" x 3/8" width. Spacing across triggers at full set 1-5/16" front to back. Now available as a cast kit for do-it-yourselfers.

Small Davis Double Set Triggers - Model 004 \$65.00



**Large Davis Double Set Trigger
Model 006**

This is the second most popular trigger of the Davis line we sell. Longer plate and triggers for heavier earlier style rifles. Technical: triggers extend 1" below plate, bar measures 5-5/8" with extra length at the back end of the bar and 3/8" width. Spacing across triggers at full set, 1-3/8" front to back. Now available as a kit.

Large Davis Double Set Triggers - Model 006 \$65.00



**Jaeger Double Set Trigger
Model 008**

This large trigger has the slant back style typical of the Germanic Jaeger style rifles of the era up to and including the Revolutionary War. Technical: Spacing across triggers at full set is 2-1/16" and front trigger extends 1" below the plate. Bar length 5-5/8" x 3/8" wide.

R.E. Davis Jaeger Double Set Trigger - Model 008 \$65.00



**Single Set Trigger
Model 003**

Set this trigger by pushing forward on the wide semi-pigtail shaped trigger. Is adjustable for pull-off as well as spring tension. The top bar is large enough to grind for perfect sear height. The design is from an original trigger with roller-cam, and exterior spring.

R.E. Davis Single Set Trigger - Model 003 \$48.00



**Davis York
Single Pull Trigger Model 005**

Appropriate for most 18th and early 19th century style longrifles and fowlers. Bar can be modified for most any application including pistols. Has 5/16" wide pigtail trigger and simple scroll design behind the pad. Design is quite well done; bar measures 4 1/8" x 7/16" and tapered.

R.E. Davis York Sole Trigger Model 005 \$28.00



Hawken Double Set Triggers - Model 0009

An accurate first rate quality reproduction of an original Hawken trigger. The bar has a ground finish while the triggers themselves are polished hardened steel. The pull-off is completely adjustable just as on the original. Plate measures 10-1/4" long x 1/2" wide. Superb workmanship.

R.E. Davis Hawken Double Set Trigger Model 0009 \$85.00



**Davis Single Pull Pistol Trigger
Model 287**

Appropriate for most 18th and early 19th century style pistols. Has 5/16" wide pigtail trigger and simple scroll design behind the pad. Measures 4-1/8" x 7/16" with tapered bar and arch to fit most profiles. Can easily be bent or cut to fit your own rifle or pistol installation.

R.E. Davis York Single Pull Pistol Trigger Model 287 \$28.00

Triggers

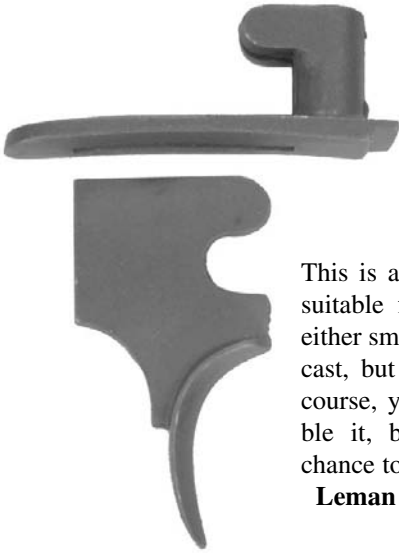

Leman Trigger

This is a moderately sized trigger suitable for a western trade gun, either smooth bore or rifled. It is as cast, but requires little fitting. Of course, you must drill and assemble it, but this affords you the chance to make it fit perfectly.

Leman Trigger & Plate \$30.00

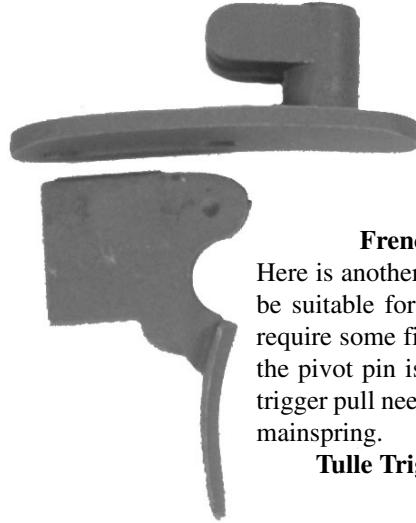

French Tulle Trigger

Here is another simple trigger that would be suitable for a fusil-de-chasse. It does require some fitting, but the drill spot for the pivot pin is marked to ensure a light trigger pull needed on a lock with a heavy mainspring.

Tulle Trigger & Plate \$30.00

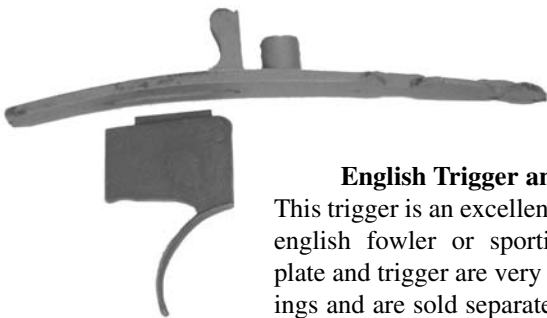

English Trigger and Plate

This trigger is an excellent choice for an english fowler or sporting rifle. The plate and trigger are very nice wax castings and are sold separately. They must be fitted and pinned together. The plate is 4-3/4" long and has a pineapple motif.

English Trigger & Plate \$30.00

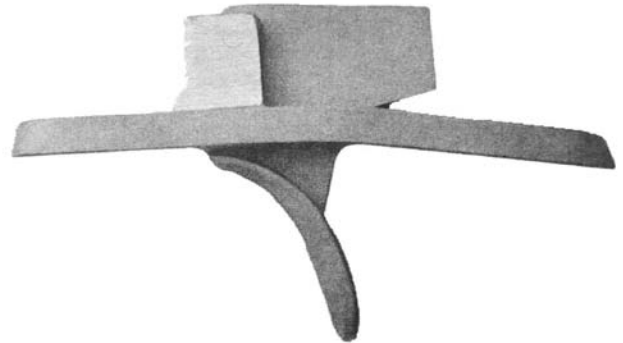

Northwest Trade Gun Trigger & Plate

Excellent trigger & bar for the N.W. trade gun. Nice castings, fits into our trade gun stock. Trigger & plate are both center punched to indicate the pivot point.

Northwest Trade Trigger & Plate \$30.00

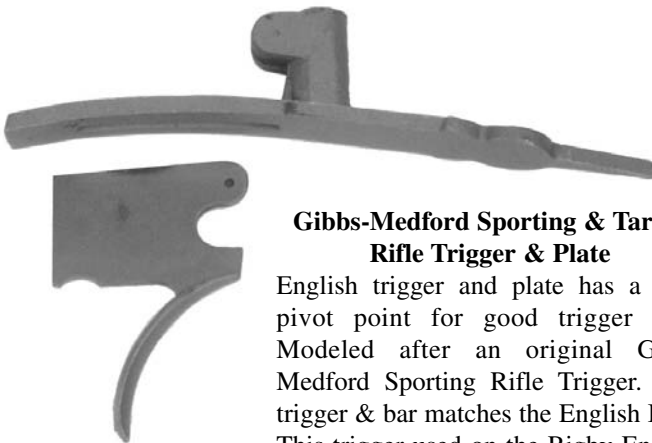

Gibbs-Medford Sporting & Target Rifle Trigger & Plate

English trigger and plate has a high pivot point for good trigger pull. Modeled after an original Gibbs Medford Sporting Rifle Trigger. This trigger & bar matches the English Bar. This trigger used on the Rigby English Sporting Rifle.

Gibbs-Medford Sporting & Target Rifle Trigger & Plate \$30.00



Bivins Trigger Single Trigger

High bar for early Flint period. Bivins Triggers are noted for their performance and their appearance.

Bivins Trigger Single Trigger \$26.00

Buttplates

Investment Cast

Winchester

Model 1885

Crescent shape.

Width 1-5/16"

Height 4-5/8"

Comb Length 2-1/4"

Steel \$28.00



Shotgun Butt

Fine checkered used on some of our early cartridge rifle & shotgun buttstocks.

Width 1-5/8"

Height 5-1/16"

Comb Length 9/16"

Steel \$29.00



Winchester Swiss

Model 1885.

Width 1-5/16"

Height 4-7/8"

Comb Length 2-3/4"

Steel \$30.00



Ballard

Copied from an original Ballard single shot.

Width 1-3/8"

Height 4-1/2"

Comb Length 1-7/8"

Steel \$28.00



English

Checkered steel used on our Rigby style target rifle.

Width 1-15/16"

Height 5-3/8"

Comb Length 2-1/2"

Steel \$29.00



Winchester Helm

Schuetzen style,

For Model 1885

high or low wall.

Width 1-3/8"

Length 4-5/8"

Comb Length 2-3/8"

Steel \$36.00



Gunsmithing Services

Install breech plug in barrel-plug is fitted tight against the inside shoulder of barrel with the tang against the barrel, \$25.00.

Install dovetail underlug, \$14.00 each.

Cut sight dovetails - 3/8" standard dovetails for front and rear sights, \$14.00 each.

Cut buttplate - rough fit buttplate to your length of pull, \$40.00

Install under rib w/screws and solder thimbles to rib, \$125.00

Cut and crown barrel, \$10.00

Drill and tap barrel for breech plug, \$30.00

Carve customers wood, full stock \$120.00, half stock \$95.00, pistol \$65.00

Install Nipple in Underhammer barrel \$20.00

Buttplates

Investment Cast

French

This Buttplate used on our Tulle Fusil de Chasse.

Width 1-15/16"

Height 5-1/8"

Comb Length 3-3/8"

Brass \$36.00

Steel \$29.00



Fowler

Most common Buttplate used on English & American Fowlers.

Width 1-3/4"

Height 5-1/4"

Comb Length 4-1/8"

Brass \$38.00

Steel \$28.00



Northwest Trade

Flat buttplate of sheet brass.

Width 1-7/8"

Height 4-1/2"

Comb Length 2-1/8"

Brass \$29.00



Lancaster

Golden age style popular for late flint or Perc. rifles our Lancaster uses this buttplate.

Width 1-3/8"

Height 4-7/8"

Comb Length 3-3/16"

Brass \$39.00

Steel \$29.00



Jaeger

Wide Buttplate for our Jaeger rifle.

Width 2-1/8"

Height 4-3/4"

Comb Length 4-3/4"

Brass \$36.00

Steel \$29.00

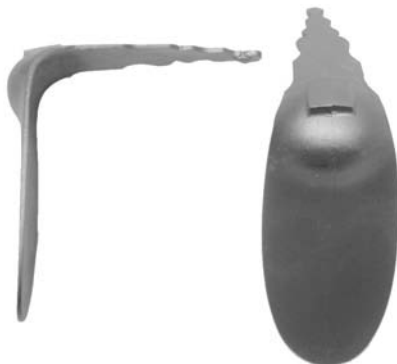

Dickert

Early style butt for late 1700's style rifles. Used on our Dickert rifle.

Width 1-13/16"

Height 4-5/8"

Comb Length 2-5/8"

Brass \$36.00

Steel \$29.00



Transitional

Wider, flatter, Buttplate for use on early style guns used on our Transitional stock.

Width 1-13/16"

Height 4-5/8"

Comb Length 2-3/8"

Brass \$36.00

Steel \$30.00



Harpers Ferry

Model 1803 & 1814 Copy of original.

Width 1-5/8"

Height 4-3/8"

Comb Length 2-1/2"

Brass \$36.00



Buttplates

Investment Cast

Hawken

For the full and halfstock.

Width 1-7/16"

Height 4-3/4"

Comb Length 3-1/8"

Brass \$38.00

Steel \$29.00



Tennessee (Bean Style)

Fits our Tennessee Mountain.

Width 1-1/4"

Height 4-3/8"

Comb Length 3-1/2"

Steel \$32.00



Leman

Correct style for our full and halfstock.

Width 1-1/4"

Height 4-1/4"

Comb Length 2-1/2"

Brass \$36.00

Steel \$29.00



Tennessee

Fits our Tennessee Classic stock.

Width 1-1/4"

Height 4-3/4"

Comb Length 3-1/16"

Brass \$38.00

Steel \$29.00



Thompson Center

For our half or fullstock and replacement stocks.

Width 1-7/16"

Height 4-1/2"

Comb Length 1-13/16"

Brass \$36.00

Steel \$27.00



Tennessee

Used on our Southern Mountain rifle.

Width 1-7/16"

Height 4-3/4"

Comb Length 3-1/8"

Brass \$38.00

Steel \$29.00



Bedford (Sandcast)

Fits Bedford or Ohio-Indiana halfstocks.

Width 1-1/2"

Height 4-1/8"

Comb Length 2-5/8"

Brass \$22.00

Sandcast:

Wax Cast Brass \$38.00

Wax Cast G.S. \$38.00



Buttplates

Investment Cast

Ohio

Smaller Buttplate
for halfstock rifles.
Fits our Ohio halfstock.
Width 1-3/8"
Height 4"
Comb Length 2-7/16"
Brass \$36.00



Vincent

Thin Buttplate only
used on Vincent rifle.
Width 1-1/8"
Height 4-1/4"
Comb Length 2-7/8"
Brass \$50.00
Steel \$35.00



Schuetzen

Heavy Buttplate for offhand
shooting Turn of The
Century style.
Width 1-7/16"
Height 5-3/8"
Comb Length 2-3/8"
Brass \$50.00
Steel \$35.00



Bonewitz

Nice Buttplate will be
correct on Verner,
Lehigh.
Width 1-5/8"
Height 5-1/4"
Comb Length 2-1/2"
Brass \$36.00
Steel \$29.00

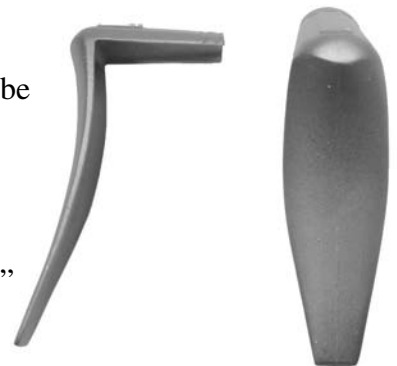

Lancaster

Golden age style,
popular for use on
Later Flintlock.
Width 1-5/8"
Height 4-5/8"
Comb Length 2-1/4"
Brass \$36.00
Steel \$29.00



Virginia

Wide Buttplate for
early style guns.
Fits our Virginia rifle.
Width 1-15/16"
Height 5-1/8"
Comb Length 2-3/4"
Brass \$38.00
Steel \$34.00



Armstrong (Sandcast)

Correct style for
Armstrong or any
Classic Golden Age
longrifle.
Width 1-1/2"
Height 5-1/4"
Comb Length 3-3/8"
German Silver \$24.00
Brass \$22.00



Verner (Sandcast)

This Buttplate fits
our Verner, Lehigh
and Early Lancaster rifles.
Width 1-11/16"
Height 5-1/4"
Comb Length 2-1/2"
German Silver \$24.00
Brass \$22.00



Triggerguards

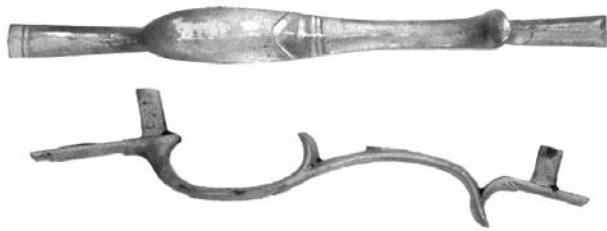

Armstrong

Correct Guard for Armstrong long rifles.
Armstrong was a Maryland gunmaker. Sand cast
Brass \$22.00 German Silver \$24.00



Lancaster

Guard similar to Armstrong but smaller.
Very pretty guard.
Brass \$38.00 Steel \$29.00



Lancaster

Classic Golden Age design. Similar
to Armstrong or Beck Style.
Brass \$22.00 German Silver \$24.00



Bedford

Long narrow triggerguard of the Bedford
County longrifle. Sand cast.
Brass \$22.00 Investment Cast \$38.00



Dimmick

Plains style guard as used on Dimmick
& Central States halfstocks.
Steel \$30.00 Brass \$38.00



Fowler

English style guard as used on Fowlers
and English sporting rifles.
Steel \$30.00 Brass \$38.00



Fowler

Fowler guard with Acorn finial.
Steel \$30.00 Brass \$38.00

Triggerguards



Jaeger

German style guard with open bow for the Davis Jaeger double set triggers.

Brass \$38.00 Steel \$30.00

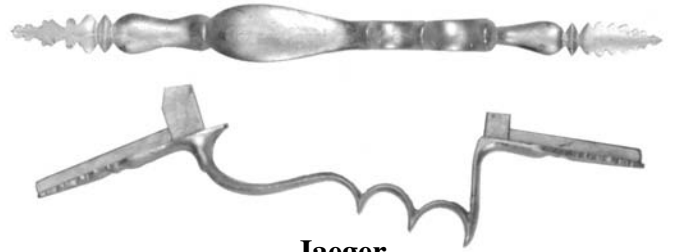

Jaeger

Finger style guard with open bow for Davis Jaeger double set triggers.

Brass \$38.00 Steel \$30.00

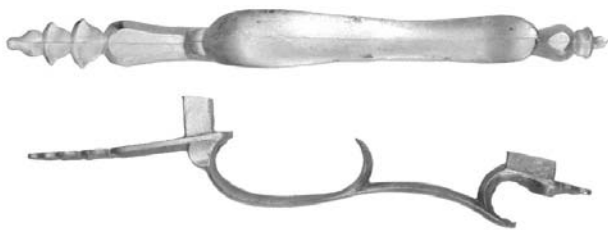

Transitional

Edward Marshall Guard for the Transitional rifle.

Brass \$38.00 Steel \$30.00

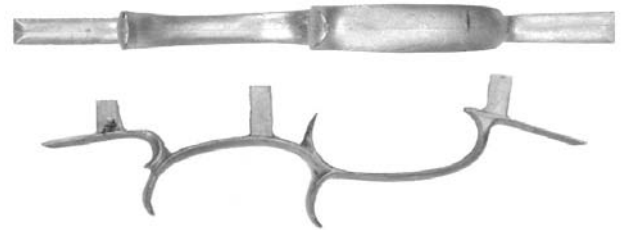

Vincent

Ohio style Vincent guard.

Brass \$50.00 Steel \$35.00

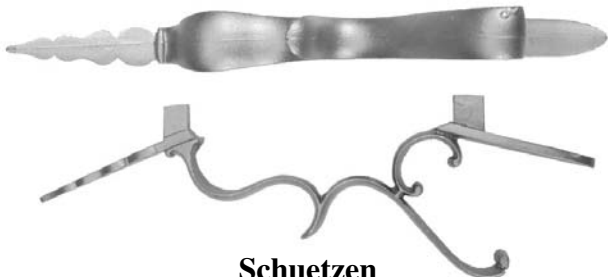

Schuetzen

Ornate Schuetzen guard for the Turn Of The Century Off-hand rifle.

Brass \$50.00 Steel \$35.00



Schuetzen

Heavier guard of German design.

Brass \$42.00 Steel \$32.00

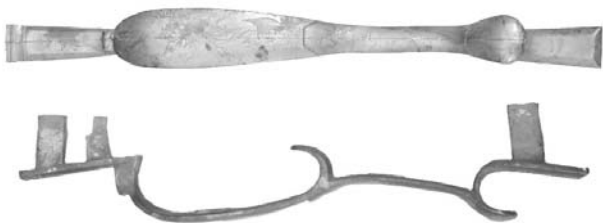

Virginia

Large Virginia guard for heavier rifles.

Brass \$38.00 Steel \$33.00



Virginia

Early style guard that works well with double set triggers.

Brass \$38.00 Steel \$33.00

Triggerguards



Hawken

A late Hawken style guard that you thread into your trigger plate.

Steel \$29.00



Hawken

A early style per 1840's with flat grip rail that you thread into your trigger plate.

Steel \$29.00



Tennessee

North Carolina style guard used on Tennessee & Southern Rifles.

Steel \$28.00 Brass \$36.00

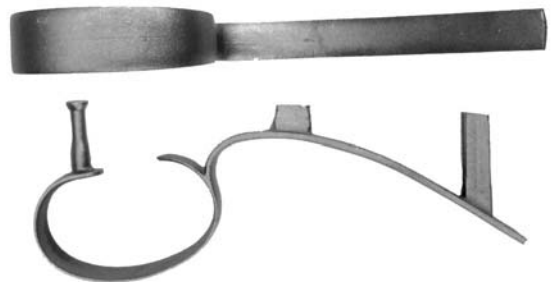

Rigby

English style guard for our Rigby sporting rifle.

Steel \$29.00



Tennessee

A typical bean style.

Steel \$33.00



Northwest Trade Gun

A plain guard as used on English trade guns.

Steel \$24.00 Brass \$32.00



Tennessee

South Carolina & Southern style guard.

Steel \$30.00 Brass \$36.00



Leman

Guard for the Leman Half and fullstock.

Also used on some Plains rifles.

Steel \$28.00 Brass \$36.00

Triggerguards



Harpers Ferry
Model 1803 guard correct for
1803-1806's early style rifles.
Brass \$38.00



Tulle
French guard that would have been seen
on the first type trade gun of the
1730-1760's fur trade era.
Brass \$38.00 Iron \$33.00



Kentucky Pistol
English flintlock pistol guard
with Early Acorn finial.
Brass \$34.00 Steel \$28.00

Gunsmithing Services

Install breech plug in barrel-plug is fitted tight against the inside shoulder of barrel with the tang against the barrel, \$25.00.

Install dovetail underlug, \$14.00 each.

Cut sight dovetails - 3/8" standard dovetails for front and rear sights, \$14.00 each.

Cut buttplate - rough fit buttplate to your length of pull, \$40.00

Install under rib w/screws and solder thimbles to rib, \$125.00

Cut and crown barrel, \$10.00

Drill and tap barrel for breech plug, \$30.00

Carve customers wood, full stock \$120.00, half stock \$95.00, pistol \$65.00

Install Nipple in Underhammer barrel \$20.00

Triggerguards

This group of triggerguards is made by the lost wax method. This produces a very high quality finish in comparison to sand casting. Investment castings are a more expensive product simply because they are labor intensive. A part is first cast in wax, then the wax is attached to a "tree" of other parts. It is then dipped and coated in ceramic which hardens around the wax. As the molten material enters the ceramic, the wax melts and the part is trapped within the coating. Usually the tree is then introduced into a bath which fractures the ceramic. Parts are then sawn off the tree. As you can clearly see, there is a whole lot to the process, and its not even done yet! Fire scaling must next be removed one parts at a time! Look for us to introduce many new products using the process in the future!



This has got to be one of our most popular Lancaster style guards. Measures 10-1/8", bow 3-1/16" x 1" deep, holds double set and Kentucky slant back triggers easily. Originally designed by contemporary maker John Bivins for a good quality style for the Lancaster School.

Brass \$38.00 Iron \$30.00



This guard is from a J.P. Beck rifle style. Beck was originally from Lancaster County which area was later incorporated into Lebanon County in 1813. His style was pure Lancaster. Look at the similarities. Length is 9-1/2", bow is 2-3/8" long x 1-1/8" deep.

Brass \$38.00 Iron \$30.00

Gunsmithing Services

Install breech plug in barrel-plug is fitted tight against the inside shoulder of barrel with the tang against the barrel, \$25.00.

Install dovetail underlug, \$14.00 each.

Cut sight dovetails - 3/8" standard dovetails for front and rear sights, \$14.00 each.

Cut buttplate - rough fit buttplate to your length of pull, \$40.00

Install under rib w/screws and solder thimbles to rib, \$125.00

Cut and crown barrel, \$10.00

Drill and tap barrel for breech plug, \$30.00

Carve customers wood, full stock \$120.00, half stock \$95.00, pistol \$65.00

Install Nipple in Underhammer barrel \$20.00

Thimbles

Ted Cash Deluxe Octagon Thimbles

The standard production thimble featuring octagon flats with cut double line grooves in either end.



Available in brass and German silver. Tabs are welded, thimble is completely polished and flats cut sharply in. This style is the easiest of the octagon flattened thimbles to inlet into the rod groove. Priced in sets of one lower and 2 upper thimbles per set.

5/16" Brass per set \$24.00

3/8" Brass per set \$24.00

7/16" Brass per set \$24.00

5/16" German silver per set \$28.00

3/8" German silver per set \$28.00

7/16" German silver per set \$28.00

Deluxe Octagon Upper Halfstock Thimbles

A matching thimble used for a halfstock. Solder to the barrel rib.



5/16" Brass \$8.00

3/8" Brass \$8.00

Trade Gun Pipes

These fine pipes have decorative rings for an authentic appearance. Made from sheet brass, polished with welded tabs. Size: 3/8" in brass only.

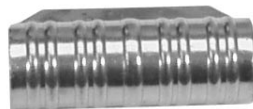

3/8" Brass only \$4.00 each

Ted Cash Deluxe Octagon Pistol Thimbles

Same as deluxe rifle sets except



has no rings in end of pipes. Set consists of one entry and one upper thimble per set.

5/16" Brass per set \$18.00

3/8" Brass per set \$18.00

5/16" German silver per set \$22.00

3/8" German silver per set \$22.00

Vincent Fullstock Thimbles

An octagon style of thimble with an extra long tail on the entry. Polished with welded tab.

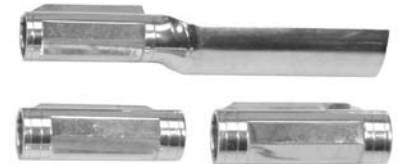

5/16" Brass per set \$24.00

5/16" German silver per set \$28.00

3/8" Brass per set \$24.00

3/8" German silver per set \$28.00

Vincent Halfstock Thimbles

A style meant to simulate the halfstock thimbles from Vincent



halfstock rifles.
5/16" Brass per set \$23.00

Thimbles

Ted Cash Plain Round

Fullstock ramrod thimbles. The plain round thimbles are smooth

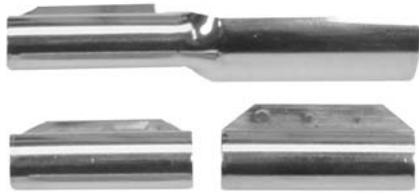

pipes and have no flats or rings.

Fullstock Thimbles Price

5/16" Brass Upper	\$5.00
5/16" Steel Upper	\$5.00
5/16" Brass Entry	\$9.00
5/16" Steel Entry	\$9.00
3/8" Brass Upper	\$5.00
3/8" Steel Upper	\$5.00
3/8" Brass Entry	\$9.00
3/8" Steel Entry	\$9.00
7/16" Brass Upper	\$5.00
7/16" Steel Upper	\$5.00
7/16" Brass Entry	\$9.00
7/16" Steel Entry	\$9.00

Brass per set	\$18.00
Steel per set	\$18.00

Upper Halfstock Thimbles Plain Round

These upper thimbles are made



for soldering onto the barrel rib for halfstock rifles.

Half Stock Thimbles Price

5/16" Brass Upper	\$5.00
5/16" Steel Upper	\$5.00
3/8" Brass Upper	\$5.00
3/8" Steel Upper	\$5.00
7/16" Brass Upper	\$5.00
7/16" Steel Upper	\$5.00

Early Round Thimbles

For Fusial and Smooth Bore guns. These new thimbles are aimed specifically at the



fowlers with graceful pointed tab on the lower entry thimble. Matching deluxe round upper thimbles compliment the set with high profile three banded wedding band style rings. Use these on any fowler or smooth rifle. Priced in sets of one lower and two uppers per set.

3/8" Brass per set	\$24.00
3/8" Steel per set	\$24.00

Deluxe Round Thimbles with Double Wedding Band

Used on many trade guns, fowlers, Jaegers as well as single barrel shotguns.



3/8" Brass per set	\$24.00
3/8" Steel per set	\$24.00

Plain Round Halfstock Ramrod Pipes

Similar to the fullstock plain pipe sets except shorter in length like the originals.

Lower pipe has a tab for pinning to the stock. Uppers are plain round



tubes with no tabs for soldering to the barrel rib.

3/8" Steel per set	\$18.00
7/16" Steel per set	\$18.00

Thimbles

Bivins Thimble Set

These are investment cast thimbles that were used on the Bicentennial guns by John Bivins and

Jack Haugh. They are 3/8" and are priced in sets of two uppers and one lower.

3/8" Brass set \$48.00

3/8" Steel set \$35.00



English Thimble Set

These are 3/8" and are investment cast. They are slightly smaller than our other cast thimbles and could be used on

English sporting rifles and fowlers.

3/8" Brass set \$34.00

3/8" Steel set \$30.00

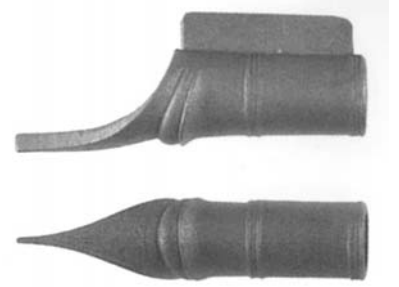

Bivins Pistol Thimbles

Here is a set of two investment cast pistol thimbles in a John Bivins style. They are available in 3/8" as well as 5/16" and would look great on your next sidearm.

5/16" Brass pistol set \$30.00

5/16" Steel pistol set \$24.00

3/8" Brass pistol set \$30.00

3/8" Steel pistol set \$24.00

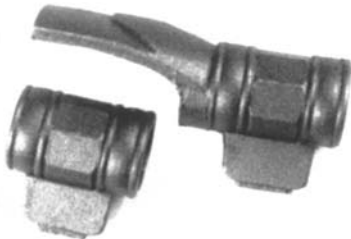

Jaeger Rifle Thimbles

Complete set, one lower entry and two uppers in 3/8" German Jaeger style.

3/8" 3 pc.

Thimble set Brass \$48.00

3/8" 3 pc. Thimble set Steel \$35.00



Gunsmithing Services

Install breech plug in barrel-plug is fitted tight against the inside shoulder of barrel with the tang against the barrel, \$25.00.

Install dovetail underlug, \$14.00 each.

Cut sight dovetails - 3/8" standard dovetails for front and rear sights, \$14.00 each.

Cut buttplate - rough fit buttplate to your length of pull, \$40.00

Install under rib w/screws and solder thimbles to rib, \$125.00

Cut and crown barrel, \$10.00

Drill and tap barrel for breech plug, \$30.00

Carve customers wood, full stock \$120.00, half stock \$95.00, pistol \$65.00

Install Nipple in Underhammer barrel \$20.00

Nose Caps

Plain Low Profile Nose Cap

Has a low profile, slightly oval with the sides curved in at the top like the originals. They are 2" long and constructed of two pieces of material silver soldered together and the muzzle cut for the proper barrel size. Available in brass, steel and German silver. Sizes: 3/4", 13/16", 7/8", 15/16", 1".



Brass and steel \$12.00 German silver \$13.00

Hawken Nose Cap

An exact copy of the nose cap used on two different Hawken rifles. It features a ramrod groove and is tapered toward the front. The front is pinched inward as were the originals. Only made for 1" barrels. Available in iron, brass or German silver.

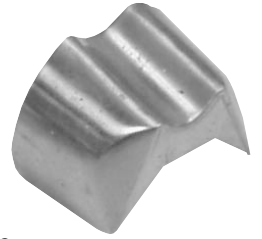

Iron or brass \$13.00 German silver \$15.00

Grooved Rifle Nose Cap

This style is not for early rifles as is our low profile. Use on very late percussion era fullstock rifles. Very well suited to use on a halfstock rifle. Available in brass, steel and German silver. Sizes: 13/16", 7/8", 15/16", 1".



Brass and steel \$12.00 German silver \$13.00

Pistol Nose Cap

These are identical to our early low profile style except they are 1" long. Available in brass and German silver. Sizes: 3/4", 13/16", 7/8", 15/16", 1".

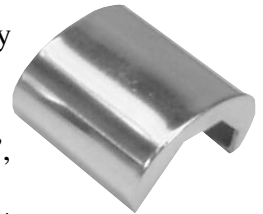

Brass \$12.00 German silver \$13.00

Chevron Rifle Nose Cap

Used by many early makers such as Frederic and Jacob Sell and John Shriver. Very distinctive looking and authentic. Available in brass and German silver. Sizes: 3/4", 13/16", 7/8", 15/16" and 1".

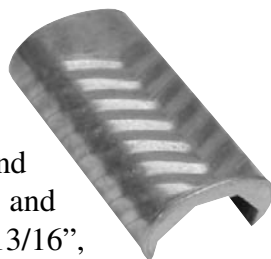

Brass \$13.00 German Silver \$14.00

Sideplates

Cut from: .090 Thick Sheet Brass & .080 Thick German Silver



From a rifle by Samuel Gobrecht of York County, PA. Size: 5-1/8" x 1"
11440 Steel \$9.00 11445 German Silver \$12.00
Brass \$9.00



Littlestown School of gunsmithing from master F. Sell. Size: 5" x 1-1/16"
11490 Steel \$9.00 11495 German Silver \$12.00
Brass \$9.00



From a rifle by J. Armstrong, Emmitsburg, MD School. Found on neighboring Chambersburg & York, PA rifles. Size: 5" x 1"
11450 Steel \$9.00 11455 German Silver \$12.00
Brass \$9.00



Clipped head sideplate from a Bedford County, PA., rifle. Size: 5-1/8" x 7/8"
11500 Steel \$9.00 11505 German Silver \$12.00
Brass \$9.00



From a Pennsylvania rifle by A. Klenedinst of York School. Has two piercings. Size: 5" x 1"
11460 Steel \$9.00 11465 German Silver \$12.00
Brass \$9.00



This plate is off an original J. Bonewitz rifle from the Womelsdorf Reading School. Size: 5" x 1-1/4"
19560 Steel \$17.50 19570 German Silver \$20.00
Brass \$17.50



From a rifle by Frederick Sell of Littlestown School. Size: 5" x 1"
11470 Steel \$9.00 11475 German Silver \$12.00
Brass \$9.00



Another common and earlier Lancaster sideplate used by early makers such as Isaac Haines. Also used widely among builders of this school. Investment Cast. Size: 4-3/4" x 1-1/8"
24060 Brass \$17.50 24070 Steel \$15.00



A very elegant Germanic sideplate styled after those of the 1740-1770 era. Appropriate for Jaegers and early American rifles and fowlers. Investment Cast. Large plate size: 6-1/8" x 1-1/8"
22070 Brass \$23.00 22075 Steel \$17.50



Lancaster School sideplate common to many gunsmiths of the school. Used widely and throughout the life of the longrifles made from this school. Investment Cast. Size: 4-7/8" x 1"
24040 Brass \$17.50 24045 Steel \$15.00

Sideplates

Cut from: .090 Thick Sheet Brass & .080 Thick German Silver



Pistol or small rifle sideplate. Brass or steel for small siler or L&R Manton lock.

Size: 3-7/8" x 3/4"

Brass \$9.00 Steel \$9.00 German Silver \$12.00



Fancy french sideplate for Tulle mount on the surface. Most remove the tail.

Size: 5-3/8" x 1-1/8"

24020 Brass \$18.00 24030 Steel \$18.00



A more plain serpent sideplate for your trade gun. Has engraving cast into the plate.

Size: 6-1/2" x 1-1/4"

Brass \$24.00 Steel \$18.00



Harpers Ferry 1803-1804.

Size: 3-1/4" x 9/16"

Brass \$10.00 Steel \$9.00



Flat sideplate correct for the Tulle.

Size: 3-1/2" 3/4"

Brass \$9.00 Steel \$9.00



This is a lock bolt inlay typical to Leman, Hawken and other plain style rifles. Countersunk cast in for 3/8" lock bolts.

Size: 1/2" x 1"

24020 Brass \$7.00 24030 Steel \$6.00



Die cut sideplate for Vincent Ohio rifles.

Size: 2-3/8" Long

24680 Brass \$5.00

24690 Steel \$5.00



Die cut sideplate for Tennessee rifles from .062" thick plate.

Size: 2" Long

24800 Brass \$5.00

24810 Steel \$5.00



This little lock bolt inlay is another typical to Hawken and plains rifles.

A countersunk hole is cast in for 3/8" bolts.

Size: 1/2" x 3/4"

20450 Brass \$7.00 20440 Steel \$6.00



A contemporary style for percussion rifles where one lock is needed.

Size: 3-3/8" x 1-1/8"

Brass \$10.00 Silver \$12.00



A style similar to some Southern guns as well as contemporary muzzleloaders.

Size: 2-1/4" x 7/8"

Brass \$10.00 Silver \$12.00



This sideplate is very typical of fancier single inlays often seen on plains or fancier rifles like those by Vogler.

Size: 2" x 7/8"

11550 Brass \$10.00

11555 Silver \$12.00

Toeplates



From an original Hawken rifle.
Size: 5" long x 7/8"
Brass \$5.00 Steel \$4.00



The "Lollipop" as seen on many Tennessee and Southern rifles. Size: 3-3/4" x 7/8"
Brass \$5.00 Steel \$4.00



As seen on an original J.P. Beck rifle. Lebanon style or Lancaster.
Size: 5-1/2" x 7/8"
Brass \$5.00 German Silver \$7.00



As found on a rifle by Wolfgang Haga, Womelsdorf-Reading School.
Size: 3-1/2" x 7/8"
Brass \$6.00 German Silver \$7.00



Jacob Dickert, early Lancaster rifle.
Size: 3-3/8" x 7/8"
Brass \$11.00 German Silver \$12.00



As seen on a York County, PA rifle by M. Fry.
Size: 5-3/8" x 7/8"
Brass \$6.00 German Silver \$7.00



From a Lebanon School rifle by Nicholas Beyer. One heart shaped piercing.
Size: 5-1/8" x 7/8"
Brass \$10.00 German Silver \$12.00



A contemporary design.
Size: 4-3/8" x 7/8"
Brass \$6.00 German Silver \$8.00



From an unsigned rifle.
Size: 3-5/8" x 7/8"
Brass \$5.00 German Silver \$7.00



As seen on some plains style rifles.
Size: 4-1/8" x 7/8"
Brass \$6.00 German Silver \$8.00 Steel \$6.00



A contemporary design.
Size: 3-1/2" x 7/8"
Brass \$6.00 German Silver \$7.00



Used on several styles by many makers.
Size: 3-1/2" x 7/8"
Brass \$5.00 German Silver \$6.00 Steel \$7.00

Patchboxes

All available in left handed on request

Close tolerance hinges are just open enough to operate. Each box we make is available left hand but you must specify at the time of order. Our boxes are made from plate stock in real German Silver and soft yellow brass, .050 thick. A full scale engraving pattern is provided with each box but **all boxes are not engraved.** (Boxes must first be installed prior to engraving.) Dimensions given are close but may not be perfectly exact. **All boxes are not engraved, but are shown and provided with patterns. Cams, springs & instructions provided with each box.**

This large single door box is a copy from the original "John Fries Gun" believed to have been made by Andrew Verner. It is an early style prior to multiple piece patchboxes.

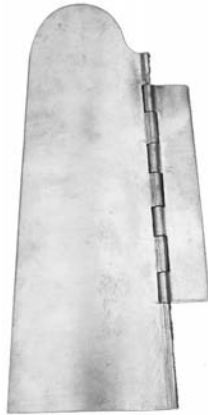

Verner worked in Bucks County, so this box would be appropriate for early Allentown rifles as well. Also very similar to single door of J. Moll.

10460 Brass \$48.00

10470 German Silver \$58.00

Single finial to door patchboxes evolved from sliding wood doors to solve the problem of bad fit and warping. This early Pre-Revolutionary style box is from an original rifle by John Rupp from the



Allentown-Bethlehem School of gunsmithing. His work is very rare.

Overall: 1-1/2" x 6-1/8"

Door: 1-1/2" x 4-3/16"

10320 Brass \$24.00

10330 German Silver \$30.00

From an original rifle by John Armstrong, this patchbox was a signature style for this maker of Emmetsburg, MD School. Similar style box was used by F. Sell of the Littlestown School and A. Schweitzer in Chambersburg School.



Finial: 1-13/16" x 3-7/16"

Door: 1" x 4-3/4", Widest Sideplate: 1" x 4-1/2".

10240 Brass \$42.00

10250 German Silver \$54.00

An elegant and simple box design from an original signed rifle by the early maker Andrew Figthorn of Reading Boro, in Berks County, PA. Note the use of the early style pointed daisy.



Finial:

1-3/4" x 3-5/16"

Door: 1" x 4-3/4"

Widest Sideplate: 1" x 5"

10260 Brass \$42.00

10270 German Silver \$54.00

This box is from one of the most famous of Jacob Dickert rifles. We believe this rifle to be one of his later and ultimate achievements. Although this box looks difficult to install and is one of our



most challenging boxes for us to make, it is actually easier to inlet than most! Overall: 3" x 7-1/8"

Door: 1-3/16" x 5"

11000 Brass \$54.00

11010 German Silver \$62.00

This box is one from a .49 cal. smoothbore rifle by Abraham Schweitzer. Another box style he used quite frequently was very similar to the 10240 above. This style is from the Chambersburg School of gunsmithing, Ca. 1828.



Finial: 1-7/8" x 3-1/4"

Door: 1-1/8" x 4-3/4"

Widest Sideplate: 1" x 5"

10300 Brass \$42.00

10310 German Silver \$54.00

Patchboxes

This was our first John Sheetz Virginia box. It is part of our complete set of furniture to make this beautiful and slim late Virginia rifle.



Finial: 1-3/4" x 3-7/16"
 Door: 1-1/8" x 5-1/8"
 Widest Sideplate: 1-3/8" x 5-1/2"
31922 Brass \$42.00
31923 German Silver \$54.00

An ornate patchbox by master engraver John Brooks in basically a Lancaster school design. Single piercing box has a touch of what appears to be the early Lancaster flower style.



Finial: 1-13/16" x 3-3/16"
 Door: 1" x 4-11/16"
 Widest Sideplate: 1" x 5"
10900 Brass \$42.00
10910 German Silver \$54.00

From a late Caleb Vincent halfstock percussion rifle. Box is made in 5 pieces. An interesting change in style. The original was not engraved.

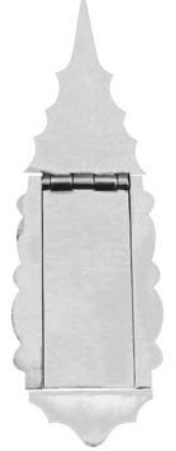

Overall: 1-7/16" x 5-3/8"
 Door: 1" x 2-3/8"
31860 Brass \$50.00
31870 German Silver \$60.00

This patchbox has become the standard for Bedford rifles. It is from an original by Jacob Stodenour of Bedford County, PA. Five piercings fully expose the curl of the wood through the box.

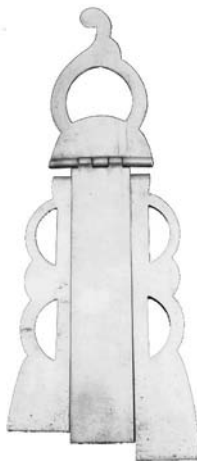

Finial: 1-13/16" x 3-5/16"
 Door: 1" x 4-11/16"
 Widest Sideplate: 1" x 5"
10980 Brass \$42.00
10990 German Silver \$54.00

Patchbox Door Release Kits

Simple, authentic, & easy to install. Comes with complete instructions, all springs, screws and parts to assemble your own release

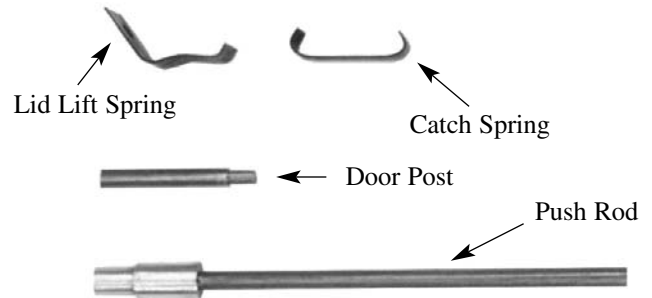

assembly to your particular need in brass, german silver or steel. Can be installed through the comb, toe or crest of the buttplate.

Brass Release Kit \$15.00

Wood Patchbox Spring



Metal patchboxes were pre-dated by wooden lids with this type of spring to "catch" the door upon closing. It was a simple concept but builders soon realized the wooden door was pre-disposed to warping.

Wood Door Spring \$14.50

Patchboxes

Isaac Haines 1750 - 1792

This original 1772 rifle is shown on page 327 of Rifles of Colonial America. It is the classic early style of Lancaster, Pennsylvania during the Revolutionary



War period. Our new domed lid patch-box is a copy from this very rifle as close to the exact size as is possible. Our Early Lancaster stock matches our replica patchbox. The contours are reproduced in most perfect detail including the sloping depth of lid to the hinge. And our hinges lay predominately above the wood. Unless you copy one yourself, you won't find a more correct box! Ours comes with open end and a piece of matching plate for your fitting the doors end. The patchbox end must be fit to the buttplate, then door ledge cut to proper size and soldered into place. Each box comes with the engraving pattern as seen here, springs and instructions for installation. All patchboxes must be installed prior to engraving! Boxes are not provided engraved but do come with the engraving pattern like the original.

10860 Brass \$50.00

10865 German Silver \$62.00

Known as the pineapple box this capbox was the common and popular Hawken patch-box. It is the most typical found on original rifles. This box was often very highly engraved.

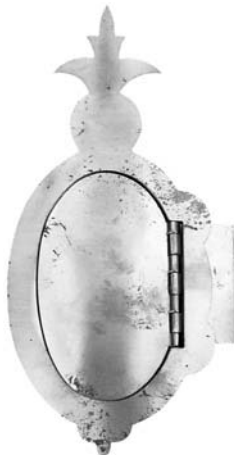

Overall: 2-11/16" x 6"

11090 Steel \$45.00

The most simple of all the Hawken patchboxes it is a style common to many of the plains style rifles. It was heavily used so its size was made large to fit the need.



Overall: 2-11/16" x 4-1/2"

11120 Steel \$45.00

An investment casting "as cast" for Leman and other plains style rifles. Will require your filing & fitting of the door, and pinning the hinge. It does not come with springs.

Length: 3-3/4"

Wide: 1-7/8"



24490 Steel \$39.00

24480 Brass \$45.00

Harpers Ferry

Military patchbox cut from heavy sheet brass. Patchbox spring and release kit included with Harpers Ferry kit.

1803 Brass \$40.00



Patchboxes

A small oval shaped cap-box common to Southern and Tennessee rifles. Springs are included.

Size:
1-1/4" wide x 3" long.



11210 Steel \$22.00

This is the favorite of all the many Tennessee style patchboxes. It is commonly referred to as the "banana box" by most builders. It was the most widely used style of all for Southern & Tennessee rifles in both flintlock and percussion rifles.



Size: 1-1/8" x 7-1/4" long.
11170 Steel \$30.00

Another Southern rifle style typical of Tennessee guns by Bean. Always found in steel not engraved.



Size: 1-1/6" x 5-1/4" long.
11180 Steel \$25.00

A Southern rifle style common to both flintlock and percussion rifles. It opens on either end and is fixed at its center.

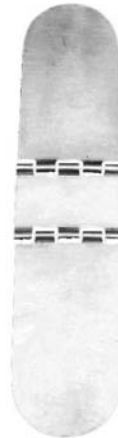

Overall:
3-1/4" x 2-5/16"
11190 Steel \$36.00

Door Catch Spring

For Tennessee and Hawken boxes. Mounts to floor or cavity. Catches the edge of the door. Use a lid lift spring to push door up.



21230 Spring \$4.00

Door Closed Spring

Installs on bottom of cavity floor or trapped underneath the finial and hinge area. Pushes up on the door from underneath.



21220 Spring \$3.50

Gunsmithing Services

Install breech plug in barrel-plug is fitted tight against the inside shoulder of barrel with the tang against the barrel, \$25.00.

Install dovetail underlug, \$14.00 each.

Cut sight dovetails - 3/8" standard dovetails for front and rear sights, \$14.00 each.

Cut buttplate - rough fit buttplate to your length of pull, \$40.00

Install under rib w/screws and solder thimbles to rib, \$125.00

Cut and crown barrel, \$10.00

Drill and tap barrel for breech plug, \$30.00

Carve customers wood, full stock \$120.00, half stock \$95.00, pistol \$65.00

Install Nipple in Underhammer barrel \$20.00

Inlays

On original rifles of early styles, inlays were limited to necessary locations, if any were found at all. However, as the increased demand of these fine longrifles continued, the artistry ascended as well. Some inlays performed a function as a wear plate for a particular location, while others were for no reason but decoration. Many were well designed at the height of the Golden Age to provide both the durability required and the decoration as well. Our die cut inlays are of .040 thick solid and pure stock.



11570 Brass \$1.00

11580 German Silver \$1.40



11610 Brass \$1.20

11620 German Silver \$1.70



11590 Brass \$1.00

11600 German Silver \$1.40



11530 Brass \$1.00

11640 German Silver \$1.40



11650 Brass \$1.00

11660 German Silver \$1.40



24940 Brass \$1.00

24950 German Silver \$1.40



25760 Brass \$1.00

25770 German Silver \$1.40



24920 Brass \$1.00

24930 German Silver \$1.40



24840 Brass \$1.00

24850 German Silver \$1.40



24900 Brass \$1.20

24910 German Silver \$1.70



11690 Brass \$1.00

11700 German Silver \$1.40



24860 Brass \$1.00

24870 German Silver \$1.40



12070 Brass \$1.50

12080 German Silver \$2.50



12190 Brass \$1.50

12200 German Silver \$2.50



24820 Brass \$1.00

24830 German Silver \$1.40

Inlays



11810 Brass \$1.00
11820 German Silver \$1.40

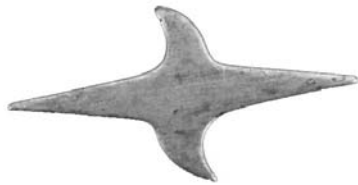

11830 Brass \$1.00
11840 German Silver \$1.40



11850 Brass \$1.00
11860 German Silver \$1.40



11870 Brass \$1.00
11880 German Silver \$1.40

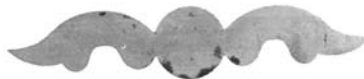

11890 Brass \$1.20
11900 German Silver \$2.25



11910 Brass \$1.00
11920 German Silver \$1.40



11930 Brass \$1.00
11940 German Silver \$1.40



11950 Brass \$1.00
11960 German Silver \$1.40



11970 Brass \$1.00
11980 German Silver \$1.40



11990 Brass \$1.00
12000 German Silver \$1.40



12010 Brass \$1.00
12020 German Silver \$1.40



12030 Brass \$1.00
12040 German Silver \$1.40



12050 Brass \$1.00
12060 German Silver \$1.40



12130 Brass \$1.00
12140 German Silver \$1.40



11710 Brass \$1.00
11720 German Silver \$1.40



11730 Brass \$1.00
11740 German Silver \$1.40



11750 Brass \$1.00
11760 German Silver \$1.40



11770 Brass \$2.00
11780 German Silver \$2.50

Pierced center is the same as inlays as 11730 - 11745. This Inlay can be fit and soldered inside an opposite star material for accent.

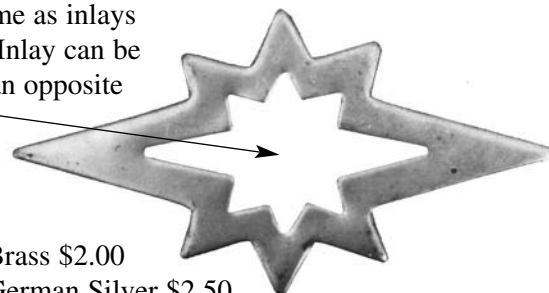

11790 Brass \$2.00
11800 German Silver \$2.50

Sights

Investment Cast Rear Sights



Traditional Rear Sight

.550 wide Base .325 high, 3/8" Dovetail \$10.00



Jaeger Rear Sight

7/16" High .480 Base, Dovetail \$12.00



Lancaster Rear Sight

.535 Base .250 High, 9/16" Dovetail \$10.00



Jaeger Rear Sight

1/4" high .480 base, Dovetail \$12.00



Long Base Rear Sight

Can be shortened to fit old dovetail
.520 Base .300 high, 1 1/4" Dovetail \$10.00



Jaeger Rear Sight

.405 High .670 Base, Dovetail \$12.00



Buckhorn Rear Sight

.540 Base .225 High, 3/8" Dovetail \$10.00



Hawken Long Adjustable Sight

Made by L&R

Top quality sight spring tempered
5-3/4" Long, 3/8" Dovetail \$51.00

Precision Milled Rear Sights



Milled Rear Sight

1/4" High overall, Base .080 Thick, 3/8" Dovetail \$12.00

Milled Rear Sight

3/8" High overall, Base .080 Thick, 3/8" Dovetail \$14.00

Milled Rear Sight

7/16" High overall, Base .080 Thick, 3/8" Dovetail \$14.00

Sights



Front Sights

German Silver Blade, Brass Base for 3/8" Dovetail
 Tall .050 Thick Blade \$8.00
 Tall .080 Thick Blade \$8.00

Investment Cast Front Sights



Flower Leaf Design
 Fits 3/8" Dovetail, Steel \$10.00

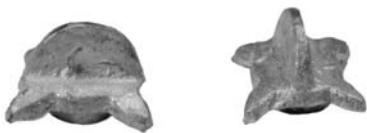

Turtle Front Sight
 Solders to Round Barrel for Trade
 Gun or Fowlers \$12.00



Fusil Front Sight
 Solders to round barrel
 for Fowlers or Tulle. \$12.00



Lyman Front Target Sight

Lyman 17A front sight with 8 inserts
 .404 height, 3/8" Dovetail \$41.50

Lyman 17A Front Sight
 .494 height, 3/8" Dovetail \$41.50
 Height is measured from bottom to center of sight

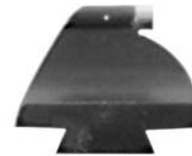

Marbles Steel Front Sight
 White bead
 3/8" Dovetail .410 high \$17.00

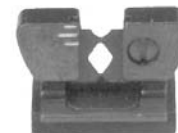

Marbles Folding Leaf Adjustable Rear Sight
 Adjustable for elevation. Can be used with either of
 above sights or silver blade front sights
 3/8" Dovetail \$25.00



Milled Front Sights
 3/8" Dovetail 1/2" high, .120 Thick Blade
 .050 Thick Blade \$10.00
 .090 Thick Blade \$10.00

Underlugs, Barrel Keys & Ribs

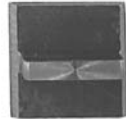

Solid underlug with dovetail base, used with barrel pins.
Base is .375 wide & .630 long. \$3.00



Concave base underlug should be soldered to round barrels used with barrel pins.
Base is .375 wide & .620 long. \$3.00



Underlugs slotted for barrel keys dovetail base.
Use with regular large key.
Use on Hawken or heavier rifles.
Base is .610 wide & .710 long. \$6.00



Underlugs slotted for smaller key.
Each measures .340 wide by .610 long.
Use with smaller keys for slim longrifles.
Steel or Brass \$6.00



Wedge Keys

Hawken and Plains Style, slotted to be pinned in place in barrel channel. Investment cast.
.365 wide x 1-3/4 long. Steel or brass \$6.00

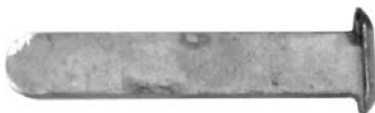

Kentucky Style Keys

Smaller keys for Kentucky or Tennessee slim long rifles. Investment cast.
.250 wide x 1-1/2" long. Steel \$6.00 ea. Brass \$6.00 ea.

Staple Underlugs



Cast staple underlug to drill thru for pin \$4.00 ea.



Cast staple underlug for large style key \$4.00 ea.



Cast staple underlug for small Kentucky key \$4.00 ea.

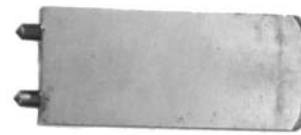

Staple Installation Tools

These tools make installing staples much simpler. Use the center punch to mark the exact spacing for the staple holes. Drill a 7/64" hole being careful to drill no deeper than necessary. Insert the staple and use the staking tool to set the ends. The concave shape of the staking tool does a good job.

Staple Center Punch \$12.00

Staple Staking Tool \$12.00



Barrel Ribs

Milled Solid Steel Ribs with Overlapping Edges.

Sizes for the following:

13/16" Barrels 24" long \$36.00

7/8" Barrels 24" long \$36.00

15/16" Barrels 24" long \$36.00

1" Barrels 24" long \$36.00

1-1/8" Barrels 24" long \$36.00

Concave rib 24" long for round barrels \$36.00

Ramrods, Tips & Jags



Hickory Ramrods

- 5/16" Hickory ramrod \$4.50
- 3/8" Hickory ramrod \$4.50
- 7/16" Hickory ramrod \$4.50



Cleaning Jags

Turned from solid brass with concave end to fit the ball. Steel threads.

Cal	Base	Thread	Price
32	5/16	8/32	\$2.75
36	5/16	8/32	\$2.75
40	5/16	8/32	\$2.75
40	3/8	8/32	\$2.75
45	3/8	8/32	\$2.75
50	3/8	8/32	\$2.75
50	3/8	8/32	\$2.75
50	7/16	8/32	\$2.75
54	3/8	8/32	\$2.75
54	7/16	8/32	\$2.75
58	7/16	8/32	\$2.75
62	3/8	8/32	\$2.75
62	7/16	8/32	\$2.75



Ramrod Tips -Brass

5/16" - 3/8" - 7/16" - 1/2"

Threaded 8/32" to accept jags, scrapers, ball pullers or worms \$2.00



Brass Fouling Scrapers

Flat face to scrape fowling from face of breech plug.

Cal	Thread	Price
32	8/32	\$2.75
36	8/32	\$2.75
40	8/32	\$2.75
45	8/32	\$2.75
50	8/32	\$2.75
54	8/32	\$2.75
58	8/32	\$2.75
62	8/32	\$2.75

Hand Taps & Drills High Speed Steel

These taps & drills are the ones most commonly used for building muzzleloaders.

Taps & correct drill on same line.

Tap	Price	Drill	Price
5/40	\$13.00	#38 .1015	\$3.25
8/32	\$10.00	#29 .136	\$4.50
10/32	\$10.00	#21 .159	\$4.75
1/4 x 28	\$11.00	#3 .213	\$5.00
5/16 x 24	\$12.00	#1 .272	\$5.00

Drums, Nipples & Touch Hole Liners



Powder Drums

Machined drums for percussion rifles & pistols.
Has two flats milled in them for easy installation.
Not drilled or tapped for nipple.

7/16" OD 5/16" x 24 TPI \$5.00
1/2" OD 5/16" x 24 TPI \$5.00
1/2" OD 3/8" x 24 TPI \$5.00



Standard Nipples Stainless Steel

Nipples for #11 Caps

1/4" x 28 nipple fits powder drums, most patent
breeches and most modern made muzzleloaders
Has two flats milled \$3.00

1/4" x 28 nipple with four flats milled square \$3.00
5/16" x 24 Musket nipple \$4.00
5/16" x 18 Enfield nipple \$4.00

Nipples for musket caps

5/16" x 24 fits most replica muskets \$4.00
5/16" x 18 British Enfield musket \$4.00

Oversized Nipples

.255 x 28 (.005" oversized) \$3.50
.260 x 28 (.010" oversized) \$3.50
.265 x 28 (.015" oversized) \$3.50
.270 x 28 (.020" oversized) \$3.50
.275 x 28 (.025" oversized) \$3.50
.285 x 28 (.035" oversized) \$3.50



Touch Hole Liners Stainless Steel

Has screwdriver slot for installation.
Shoulder is tapered for good fit.
They are counter bored from the
inside for fast ignition.
1/4" x 28 TPI \$3.00
5/16" x 24 TPI \$3.00

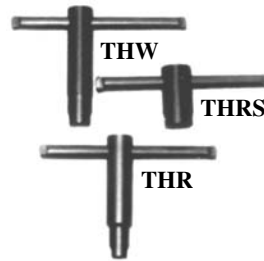

T-Handle Wrenches

The same material as our
attachment heads for our
Ratcheting Nipple Wrench but
made into a T-Handle

T-Handle Walker Dragoon	THW	\$9.00
T-Handle Rifle/Shotgun	THRS	\$9.00
T-Handle Revolver	THR	\$9.00



Ratcheting Nipple Wrench

Easy to use ratcheting nipple wrench. Heavy duty
"American Made" ratchet with custom made
ratchet head with hardened steel that fits #11 nip-
ples on rifles or shot guns and musket nipples or
pistol nipples. Tapered fit, standard 1/4" hex,
interchangeable heads.
#11 Nipples \$20.00
Musket Nipples \$20.00
Pistol Nipples \$20.00
Heads only \$10.00

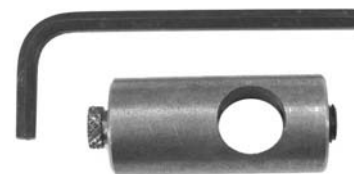

Drum Drilling Jig

Makes it easy to tap blank drums for correct nipple
alignment with the hammer \$28.00

Cappers & Measures



Cash Rifle Capper
Most popular capper available.
Holds approximately 75 #11 Caps
Brass \$33.00

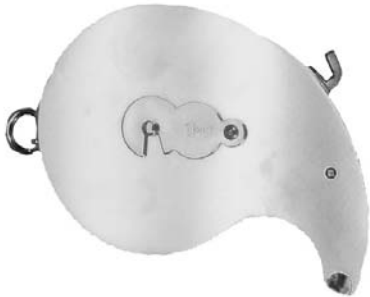

Cash Universal Rifle and Revolver Capper
Used for revolvers as well as most rifles.
Holds about 100 #11 Caps
Brass \$35.00



Cash Inline Capper
Solid body of brass. Caps do not tip in channel.
Holds about 20 caps. Good for inline rifles.
Musket size also available
Brass Capper for #11 caps \$14.00
Brass Capper for musket caps \$21.00



Flintlock Pan Primer
Dispenses about 3 grains of powder each
time you prime the pan.
Brass \$16.00

Adjustable Powder Measures



This measure is made of brass and is adjustable from 9 to 120 grains. It is marked in 5 grain increments, but can be set at any point in between. It has a swing over spout. \$21.00



This is the same measure as above except that it does not have the swing over spout. \$18.00



Fixed Powder Measures

Fixed powder measures for just the right amount! Each one has the grain amount stamped right on it for easy reading. Made of quality brass tubing with a perfect top for hanging around your neck for easy use in the field.

PW-20	\$5.25	PW-90	\$5.25
PW-30	\$5.25	PW-100	\$5.25
PW-40	\$5.25	PW-110	\$5.25
PW-50	\$5.25	PW-125	\$5.25
PW-60	\$5.25	PW-150	\$5.25
PW-75	\$5.25	PW-200	\$5.25

Sling Swivels & Flints



Sling Swivels

Made from high quality investment castings, each of these swivels are drilled, tapped and ready to install on your rifle. Finish is a slight rough texture suitable for browning. Screws are 6-32 and fit most all stocks.

Sling swivel \$12.00 each

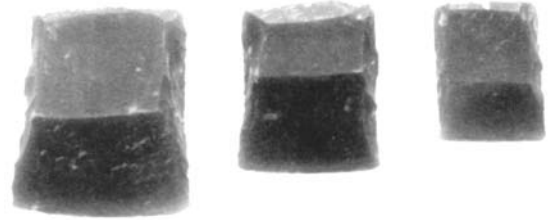

Black English Flints or French Amber Flints

5/8" Small Locks

Small Siler
L&R Manton \$2.50

3/4" Medium Locks

Large siler, T/C,
L&R Hawken, Dur's Egg,
1803 Harpers Ferry \$2.50

7/8" Large Locks

L&R Trade Gun, Tulle,
Davis Jaeger,
Chambers Fowler \$2.50



Sling Button

Appropriate for Fowlers and early rifles. **\$8.00**

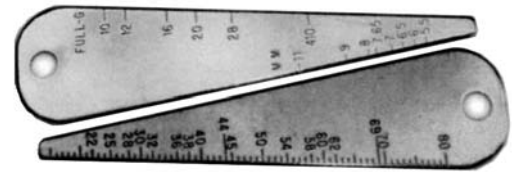

Bore Gauge

Copied from an original. Easy to read numbering. One side caliber up to 80 and the other side is shotgun bore up to 10 gauge. Also metric sizes. Handy to carry on a chain, use in stores, firing line or gun shows, etc. You can also get your logo, phone, address or email stamped on these. Call for details.

Brass	BG	\$3.50
German Silver	BG-3	\$5.50



Flash Cups

Fits under the nipple to protect the stock and barrel from cap flash.

Brass \$4.00

Miscellaneous Parts

Lock & Tang Screws



We make lock and tang screws in 8/32" and 10/32" thread sizes. They are 2" long. Lock screws are available with flat heads & square shoulders and with oval heads. Tang screws have oval heads and are designed to be countersunk.

Lock Screws

8/32" and 10/32"
3/8" head \$1.75

Tang Screws

8/32" and 10/32"
5/16" head \$1.75
All are 2" long

Barrel Rib Screws

5/40 and 6/40 thread
3/16" diameter head 7/16" long \$.30

Hammer Screws

6/40 7/16 head
1/2" long \$1.00

Wood Screws



All screws unplated

1-1/4"	#10 Oval head	.50¢ ea.
3/4"	#6 Oval head	.15¢ ea.
5/8"	#4 Flat head	.15¢ ea.
1/2"	#4 Flat head	.10¢ ea.
1/2"	#2 Flat head	.10¢ ea.
3/8"	#2 Flat head	.10¢ ea.
1/4"	#2 Flat head	.10¢ ea.



Brass Shaft Ball Starters

With removable nylon guide and replaceable tip.
Hardwood ball handle with brass shaft
and nylon muzzleguide.

Comes in sizes for barrel in:
32" - 36" - 40" - 45" - 50" - 54" & 58" \$15.00 each

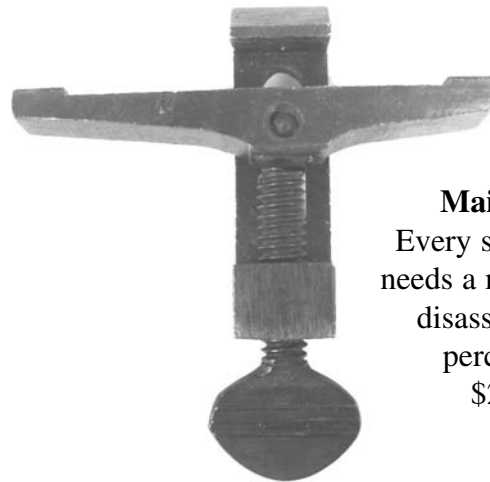

Mainspring Vise

Every shooter or builder
needs a mainspring vise to
disassemble flint and
percussion rifles.
\$28.00 each.

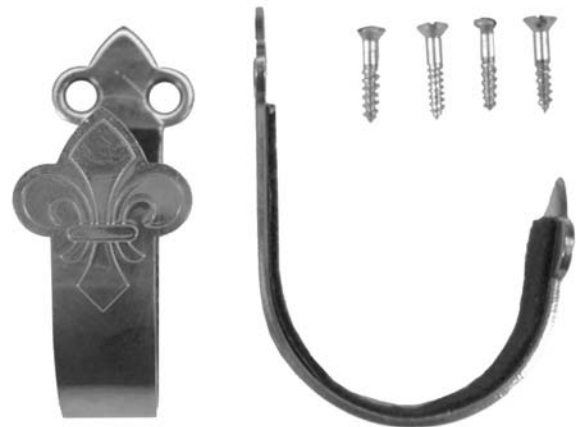

Gun Hangers

Made from heavy weight brass with soft strip
of felt to protect the wood finish. Comes with
mounting screws. \$22.00 pair.

Finishing Products



Wahkon Bay Products 2 oz. Bottles

Have been used by gunsmiths, sportsmen and rifle builders for many years.

Aquafortis for coloration of maple stocks is not a stain. It is a strong reagent for blushing and darkening hard woods which is actuated by applying heat. It is easy to use but caution must be exercised since this product contains nitric acid. The formula for this product is 200 years old. **\$9.50 each**

Tru-Coat Gunstock Finish by Wahkon Bay will produce a fantastic finish when used according to directions. This is a slow and deep-penetrating finish. The product is often used to renew old finishes and restore their patina. **\$8.00 each**

Tru-Brown by Wahkon Bay. We have tried many browning formulas and this is the one that produces the most authentic and rich deep brown of any we have ever seen or used. The fact that an even, streak and spot-free finish can be obtained without heat or boiling makes this process a pleasure to use. The secret is in a good degreasing agent and in the careful following of instructions that the firm provides. **\$8.00 each**

Tru-Blue by Wahkon Bay is an original old bluing formula that will produce a rich and deep blue-black finish, similar to the finish found on old fowlers and Jaegers. No tank is required, nor do you need to apply heat. This process is excellent for redoing old double barreled shotguns since you need not worry about barrel separation. **\$8.00 each**



Wonder Lube 1000 Plus

Small 4 oz. tub of Wonder Lube \$6.95 each

Large 12 oz. tub of Wonder Lube \$17.00 each

For use with your own patching material or pillow ticking. Same lubricant as on the pre-cut wonder patches.



Homer Dangers Stain 2-1/2 oz. Bottle \$8.00 each

These are the stains Homer Dangler developed many years ago. A very simple blend of subtle pigments to produce three very nice stains. Available in a real golden brown that lightly accents the stripe, a darker brown walnut, and an interesting red brown hue that seems to work well either alone or with one of the other browns for accent. Non-grain-raising alcohol based stain.

Inletting Black 1/2 oz. \$14.00 each

Indispensable for stock inletting or fitting stock accessories such as curved butt plates. Easy to apply with small brush. No mess or staining. Washes off hands and clothes easily. Makes a good clear mark.



AcraGlas Gel

AcraGlas serves two major purposes. It was initially designed as a repair epoxy, it has fiberglass in it. The second purpose is the bedding of barrels. It provides such a stable solid and structural platform for your barrel that it has been proven as an accurizing product for serious competition shooters.

Two Gun 4 oz. kit \$29.95



Old West Snake Oil

Antique firearm finish protector and preservative. A blend of pure carnauba wax and highly refined mineral oil. Safe for all finishes - is non-hardening and does not soften the wood.

#1 - 8 oz. bottle \$20.00

#2 - 4 oz. bottle \$16.00

#2 has pre-64 Winchester stain added



Finishing Products



Laurel Mountain Stains

Deep Penetrating, designed to penetrate deep into wood so surface scratches, abrasion and other wear damage will not expose raw, unstained areas.

Non-Grain-Raising, supplied in a special solvent blend that will not swell grain, checkering, carving or tight inletting.

Light Fast Dyes, used are exceptionally light fast. Antique Wood Stain is more permanent than pigmented stains.

Rich Colors, available in many popular colors that enhance the grain and figure of all woods. Adds depth and clarity that can't be obtained with pigment type stains. All colors of Antique Wood Stain can be intermixed to obtain additional colors.

Concentrated, Antique Wood Stain is concentrated making it economical to use. One 4 oz. Bottle will stain many stocks. It can be reduced to obtain lighter shades for even more economy.

Available Colors

American Walnut \$19.75 each

Classic color used on American walnut stocked firearms over the last century. Much less red in color than Walnut or Cherry Stains. When used on lighter toned woods, produces a rich brown stain without the amber or red undertones of other colors.

Cherry \$19.75 each

Deep, rich red-brown color. Brings out red undertones when used on cherry or any other wood. Duplicates the color of 18th and 19th century firearms from Lehigh and Northampton County, Pa., when staining maple. Matches the classic red-brown used on high quality European firearms, when used on walnut. Color similar to that obtained with the natural stain alkanet root, but with the exceptional light fastness characteristic of all Laurel Mountain Forge Stains.

Lancaster Maple \$19.75 each

Rich brown color with honey-yellow undertones. Color popular in 18th and 19th century in Lancaster County, Pa. One of our favorites.

Nut Brown \$19.75 each

The light addition of Lancaster Maple. It is a light golden base color with red and brown tones.



Laurel Mountain Permalyn Sealer & Finish

Permalyn Gun Stock Finish \$19.75 each

Permalyn Finish has unexcelled durability. It is impervious to water, alcohol, detergents, bore cleaner and most other chemicals and solvents. Permalyn has the durability to withstand handling and rough usage in the field, yet it is unsurpassed for beauty and ease of use. Permalyn Gun Stock Finish is formulated to fill the grain and quickly build the finish to the desired gloss.

Permalyn Sealer \$17.60 each

Permalyn Sealer is made from the same base oils and polymers as Permalyn Gun Stock Finish, but contains special ingredients to insure deep penetration into the stock. This affords maximum durability and insures that surface damage cannot expose raw wood, allowing moisture damage.

Though either Permalyn Sealer or Permalyn Finish can be used alone, for maximum durability and economy they should be used in conjunction with one another.

Laurel Mountain PermaWax Cleans - Seals - Protects \$15.00 each

PermaWax is a unique blend of waxes, polymers and UV protectants, specially formulated to stand up to wear and weather. The UV protectants shield wood, stain and finish from the damaging effects of sunlight.



Laurel Mountain Cold Brown 2-1/2 oz. Bottle \$15.50 each

This cold brown by Laurel Mountain is the quickest acting cold brown. It usually takes only two days to apply six to eight coats necessary to get a rich chocolate brown. This solution was specially formulated to not contain mercury or any other type of toxic ingredients. Easy to use, fairly quick and results are attractive.



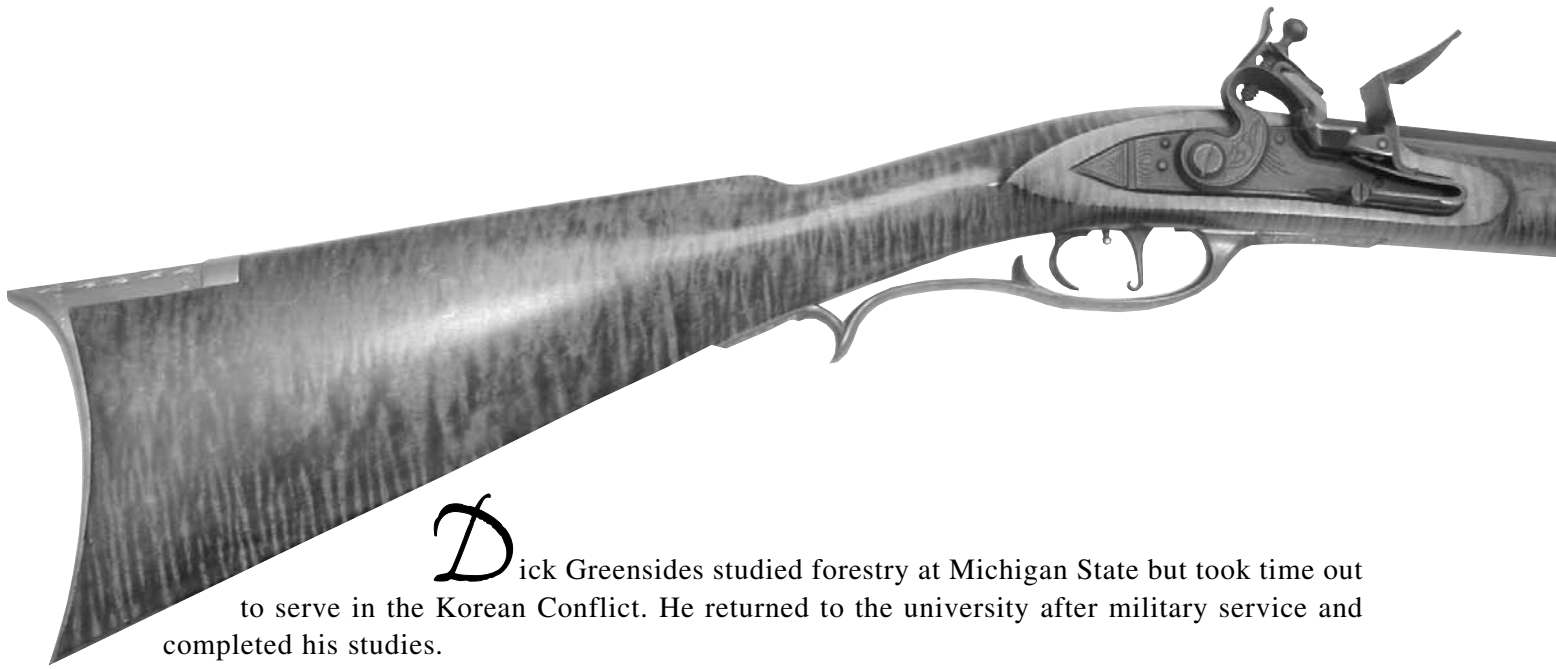

*D*ick Greensides studied forestry at Michigan State but took time out to serve in the Korean Conflict. He returned to the university after military service and completed his studies.

Dick worked for a lumber company before going into millwork. He has been in the lumber business all his life. He began shooting black powder around 1958 and his ribbons, trophies – as well as members of the local black powder club – attest to his shooting skill.

Pecatonica River has been in business for many years. Readers of “Muzzleloader” and “Muzzle Blasts” are familiar with the Pecatonica River Long Rifle Supply Co. through ads carried in both magazines.

Our company offers top quality goods at prices black powder shooters can afford. We stand behind our products and won’t sell anything we haven’t tested and wouldn’t use ourselves. We sell to our friends and are reliable.

Muzzleloading takes a special kind of person to really enjoy the sport. It calls for an appreciation of our heritage and traditions. Craftsmanship is one of those important traditions we want to help keep alive.

Black powder shooting is like holding history in your hands, your firearm should reflect the quality of our heritage. We'd like to help you do it right.

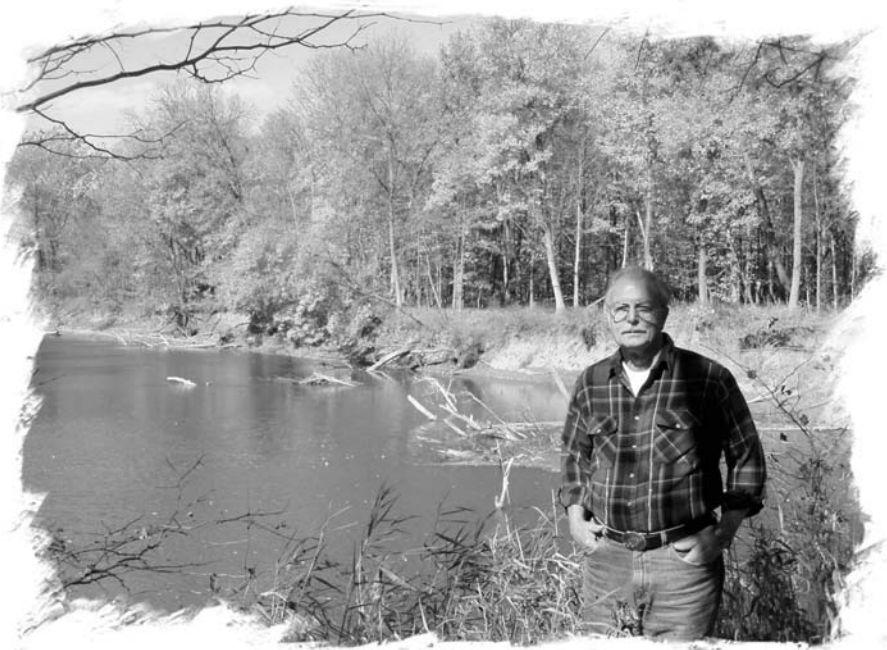

Dick Greensides



Phone: 815-968-1995
sales@longrifles-pr.com • www.longrifles-pr.com